

# WITE BACK

magazine

no. 8



ON THE INSIDE

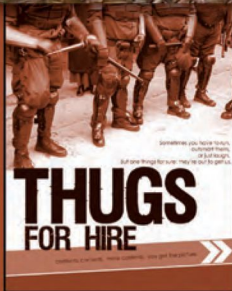

THUGS FOR HIRE

PG9

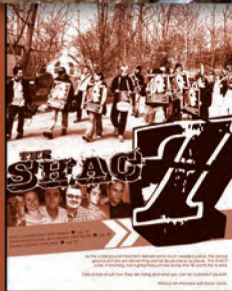

THE SHAC7

PG18

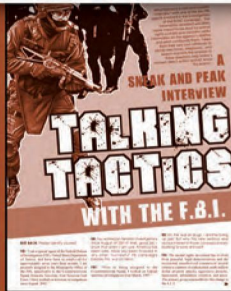

A SHOCK AND PEAK INTERVIEW  
**TALKING TACTICS**  
WITH THE F.B.I.

FBI INTERVIEW

PG19



HOW IT WAS DONE  
JAPAN LAB RAID

PG19





## ON THE COVER

2 of 15 liberated turkeys bathe in the sun after a christmas eve liberation in the uk.

# BITE BACK

magazine

222 Lakeview Ave.  
Ste. 160-231

West Palm Beach, Florida 33401  
BiteBack@DirectAction.info  
Ads@DirectAction.info  
www.DirectAction.info

*Bite Back* is a volunteer organization and magazine dedicated to the advocacy of those caught or currently in the underground for animal liberation and the nonviolent tactics they employ. *Bite Back* strives to create a culture of support for the Animal Liberation Front and direct action by means of prisoner aid, news reporting, the publication of inspirational stories and photos, and the production of pro-ALF merchandise.

Formed in 2002 to feed an animal rights movement hungry for ALF advocacy, *Bite Back* is all volunteer, grassroots-organized, and free to political prisoners.

### SUBSCRIPTIONS

*Bite Back* is a 32 page quarterly. Subscriptions are \$15/year (\$10 low income/student) or \$20 international (US funds are preferred, but we do accept euros and pounds). We accept checks or money orders (made payable to *Bite Back*), well concealed cash, or PayPal (credit card) payment online via our website.

If you are interested in distributing *Bite Back* at your store, distro, or infoshop, get in touch for bulk rates.

### BACK ISSUES

Back issues are \$2 each. Please send a letter describing which issue you would like, the quantity and the necessary funds. NOTE: Unfortunately, we are SOLD OUT of issues 1 - 4.

### SUBMISSIONS

*Bite Back* welcomes all submissions for articles. They may be sent via email or mail. Articles may have an author or be anonymous; please specify when sending an article. Pictures are also always welcome. If possible, please send hard copies to the address, as email attachments will not be opened for security reasons. Videos may also be submitted for review, distribution, or *Bite Back* TV featured on the website. Your ALF/direct action related merchandise may also appear in the magazine for sale. Contact *Bite Back* about wholesale rates.

### DISCLAIMER

*Bite Back*, its designers and contributors are not responsible for actions on the part of any individual which proves defamatory, injurious or prejudicial to the individuals or entities named herein, their families, or acquaintances. This publication is provided for informational purposes only, and is not intended to incite any criminal action on the part of its readers.



# \* TABLE OF CONTENTS.

PRISONER LETTERS	PG.4
NEWS FROM THE FRONTLINES	PG.6
SUPPORT PETER	PG.8

<b>THUGS FOR HIRE</b>	PG.9
-----------------------	------

AGENT TO AGITATOR	PG.10
HANDLING INVESTIGATIONS	PG.13
BLOOPERS & BOBBIES	PG.14
TERRORIST I.D.S	PG.16
FEEELING THE JET BLUES	PG.17

<b>THE SHAC 7</b>	PG.18
-------------------	-------

TALKING TACTICS	PG.19
THE SHAC7 & ME	PG.22
SHAC SECURITY	PG.24

HOW IT WAS DONE	PG.26
IT ALL ADDS UP	PG.28
HISTORY LESSONS	PG.29
GO GO GADGET	PG.30
DIARY OF ACTIO	PG.32
IN CONCLUSION	PG.34
MEP...RSCRI...NS	PG.35



## editorial

*"When Weather first went underground, in 1970, the conventional wisdom was that we'd be rounded up within a year. You don't remember the 50's. I grew up in the 50's. In every TV program, the police or the FBI always got their man. . . . So there was a psyche, in the population, that it was impossible to defy the FBI. Everybody thought, 'this is only going to last for a few months.'"*

-Political prisoner David Gilbert, speaking in the documentary *The Weather Underground*

With a few important exceptions, activists in the Weather Underground did remain free for years, despite carrying out dozens of bombings of corporate and government offices, including the U.S. Capitol.

Crimes are rarely solved through the use of DNA technology, sophisticated surveillance or other techniques of modern policing that you see on television these days. Instead, the majority of convictions are achieved through evidence given by the accused. Sadly, in only a small percent of cases do people arrested exercise their right to keep silent. Testimony of snitches has also been a big problem for the animal rights and radical environmental movements.

It is important not to let fear of prison cripple us (or courtroom battles divert us), but we must recognize the intentions of law enforcement and the courts to limit our movement.

The animal rights movement has learned that it is not only leaders who are arrested. We are all possible targets, every time we attend a demonstration or a meeting, or hand out a leaflet.

In this issue, we focus on law enforcement. Not just the run of the mill security checks (those are important, and in there too) but rather we 'infiltrate' those who infiltrate. We talk with an ex-FBI agent, get a few laughs (and lessons) from activists' mishaps with the coppers, examine why you can't fly anymore and what exactly IS on your ID?

At the center of the FBI's target is the SHAC 7. Get an indictee's take on the situation, see how the FBI is trying to dismantle SHAC (and your right to free speech) and what you can do to protect yourself.

As Bite Back grows into its new shell, so must activists. Don't fear the coming oppression, rather come up with creative ways to avoid it. Activists have done it in the past and we certainly can do it as well. With our heads focused, our hearts strong and our fists clenched, there's no storm we can't weather.

**Bite Back Magazine**



# FROM BEHIND THE BARS.

THEY'RE IN THERE FOR THE ANIMALS.  
WE'RE OUT HERE FOR THEM.

For updates on animal liberation prisoners,  
and current prisoner addresses, please visit  
[www.DirectAction.info](http://www.DirectAction.info).

## UPDATES

- British activist **Barry Saul Dickinson** has been released from prison. Welcome back Barry!
- **Peter Young** has been arrested after being wanted by the FBI for 8 years for a series of fur farm releases in the USA. *More info: pg. 8*



**Paul le Boutillier** #KA9326  
HMP Wealstun  
Walton Road  
Thorp Arch  
Wetherby  
LS23 7AZ  
UNITED KINGDOM

Paul le Boutillier is serving a 2 ½ year sentence for making phone calls to various animal abusers including Covance staff at work and at home, HLS shareholders, hunt scum, farmers, agricultural suppliers and other low life.

Paul is due to be released in summer 2005.



**Daniel Hedqvist**  
Torsgården  
618 33 Kolmården  
SWEDEN

Swedish animal rights activist Daniel Hedqvist was sentenced to 10 months imprisonment for his role in an "open" action in which the activists turned themselves in voluntarily to the police after they had smashed up a chicken hatchery.



**John Wade** #38548-083  
FCI Petersburg Low  
P.O. Box 1000  
Petersburg, VA 23804  
USA

John is serving 37 months for Earth Liberation Front actions against a number of targets including McDonalds & Burger King, and against urban sprawl.



**Christopher McIntosh**  
30512-013  
FDC Seatac  
Federal Detention Center  
P.O. BOX 13900  
Seattle, WA 98198  
USA

Chris was arrested in February, accused of an arson attack on a McDonald's in Seattle in 2003.

Donations to help Chris buy stamps and other basic necessities can be sent to the address below. Money must be sent in the form of a money order or money gram.

Lockbox, Federal Bureau of Prisons  
Christopher McIntosh #30512-013  
P.O. Box 474701  
Des Moines, IA 50947-0001



**Dave Blenkinsop**  
EM7899  
HMP Rye Hill  
Onley  
Warwickshire  
CV23 8AN  
UNITED KINGDOM

Dave is serving a total of 10 years: 3 years for attacking the Managing Director of Huntington Life Sciences, 18 months for burglary in connection with "theft" of 600 guinea-pigs from Newchurch Farm and 5½ years for possession of incendiary devices.

# PROFILES



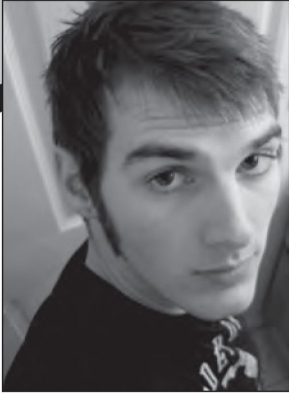

**JOSH  
DEMMITT**

**Joshua Demmitt #12314-081**  
FCI Sheridan  
P.O. Box 6000  
Sheridan, OR 97378  
USA

In February, Josh Demmitt began a two and a half year sentence for setting fires at an animal science farm at Brigham Young University. In an earlier action at BYU, six rabbits and seven birds were liberated from the farm.

"I told the judge I had no regrets and while talking to reporters I said I was going to support the animal liberation movement until the day I died, I also urged everyone to get involved in this struggle for equality because it is a cause that effects us all whether we like it or not; also be careful who you play with some people have a very hard time keeping their mouths shut.

**Josh"**

Josh's co-defendant, Harrison Burrows, snitched on Josh for a lighter sentence. But in typical fashion, the government sold him out as well, giving him the same sentence as Josh. Goes to show that snitching will get you nowhere, except in jail without outside support.

Josh has had trouble finding vegan food to eat, and getting the prison to take his diet seriously, but he is in good spirits. Donations are appreciated to help cover the cost of postage and telephone calls, travel expenses for prison visits, reading material for Josh, and other ways of making his time in prison a little easier. Donations can be sent to:

**The Josh Demmitt Support Group**  
c/o The Animal Defense League  
P.O. Box 1587  
Huntingdon, NY 11743

For updates on Josh's case, visit the Josh Demmitt Support Group's website:  
[www.SupportJosh.com](http://www.SupportJosh.com)



**SARAH  
GISBORNE**

**Sarah Gisborne**  
#LT5393  
HMP Cookham Wood  
Rochester  
Kent  
ME1 3LU  
ENGLAND

In late February, Sarah Gisborne received a 6½ year sentence for damaging vehicles of people associated with Huntingdon Life Sciences. At trial, the prosecutor paid Sarah a compliment by describing her "crimes" as "a well-planned and efficient set of actions carried out with almost military precision." This is Sarah's third prison sentence. Sarah's birthday is July 5.

"I can't write what I really want to as I want to get out of here before I collect my pension. What I can say is that it is working - it's never quick enough for us or them - but the fact remains if we do nothing things will not change.

When the judge said 6 and a half years, I just smiled; held my head high and thought of what is to come- ACTION.

It's great to know that Huntingdon will have no peace, wherever they or their affiliates are in the world. I'm kept up to date with all that is happening. Unfortunately I will just have to be a spectator for a while - something I don't like doing.

Some of the rooms here at Holloway have windows which you can talk out of to your neighbour in the next room. If you put your arm out you can have contact - which if they need support is comforting for them or you. Why I tell you this is a picture that will always be fresh in my mind is that of two primates holding hands through the bars of their separate cages. The difference is I'm here of my own doing and I will get out alive and will endure no torture. They did not get out and they were tortured mentally and physically. Do not feel sorry for me. Do not feel sorry for them - I'm still very angry as I was on my first demo.

Please be angry, please be active.  
Keep up the fight, **Sarah"**



**SERGIO MARIA  
STEGANI**

**Sergio Maria Stefani**  
*Released to house arrest!*

In April 2005, Sergio was sentenced to 2 years, 8 months in prison but has been released on house arrest during his appeal. Sergio was accused of vandalizing several fur stores and butchers, and placing an incendiary device outside of a butcher shop in the city of Arezzo. Sergio has been involved with several animal rights campaigns, and in particular the Close Morini Farm campaign (Morini is a laboratory animal supplier which breeds dogs and rodents for torture & death at the hands of vivisectioners).

*[Letter translated from Italian:]*

"I have been in prison for months already, and there is a possibility that I will remain here for a very long time. I must admit that this experiment is less horrible than I had feared, although I do not want to disrespect those prisoners who suffer deeply, nor pretend to be unaware of the violence of prison. Prison violates your dignity and aims to destroy you as an individual by preventing any form of freedom or intimacy.

It is unbearable to see wrists enclosed in shackles; forced inactivity is odious, and dreams are disrupted by the noise of the gates. But I consider myself lucky compared to those who divide their day into hours, minutes and seconds; the ticks and tocks of their wrist watches sound identical to the din of the chains. Their horizons are blocked by the concrete of the factories and they are confused by the noises produced by machines, radio and television and by the ringing of the cell phone. They are not able to hear the voice of our Mother Earth which invites us to remake our existence, to rediscover the joy of communion with life and the thrill of being alive and being able to act.

Prison has not brought me any illumination, only a stronger conviction that we are right and it is legitimate to use all means to cut down a system which not only produced, but also tries to legitimate the prison and all the other cages.

I will never regret not having achieved the goal of my fight, because to act to destroy those who want to reduce humans, the animals and our Mother Earth was liberating.

There remains in me the feeling of being freer than these pale figures who hold the keys to my cage, and the hope that those who are angered by my situation will transform their rage into a weapon against the system which imprisons me, and continue the fight which I always feel close to.

**Sergio"**





number 32 of 89  
dogs rescued by the USDA 

# ANIMAL DEALER PUT OUT OF BUSINESS

One of the country's largest cat and dog dealers is shut down by a Last Chance for Animals undercover investigation

(Arkansas, USA) C.C. Baird, an Arkansas animal dealer who has long been a target of animal rights groups, reached a settlement with the USDA in January. Baird and his wife paid a \$262,700 fine, the largest fine ever under the Animal Welfare Act. The licenses of C.C. Baird, his wife Patsy, and their two daughters, Patricia and Jeanette, have all been permanently revoked.

Since Baird started as an animal dealer in 1989, it is estimated that more than 10,000 animals passed through his hands. Baird would sell animals to research labs that he purchased at flea markets or from individuals. Baird has also been

suspected of selling stolen pets. A Last Chance for Animals undercover investigation in 2003 documented abuse and neglect of hundreds of dogs.

The USDA attorney prosecuting the Bairds said that they violated "practically every regulation that has to do with cats and dogs."

Efforts are now underway to find homes for the nearly 300 animals confiscated from the Baird compound, or to reunite them with their owners.

For more information on the rescue, visit:  
<http://www.lcanimal.org>

An investigator risked their life working undercover for months on the farm.



## ANIMAL RESEARCH CAN BE EXPENSIVE

(Iowa, USA) The University of Iowa has announced that last November's raid by the Animal Liberation Front caused at least \$450,000 in damages. The raid rescued hundreds of mice and rats from a cruel death, and left animal labs and vivisector's offices in shambles. The University noted that the damage would not be covered by insurance.

In a related story, the FBI released a description of a suspect in the raid: a young woman of average height, "unknown" weight and dark hair, wearing a grey sweatshirt. If this sounds like anyone you know, the FBI would like to talk to you!



## YOU CAN TRASH MY HOME FOR HALF THAT!

(California, USA) John Feldman of the band Goldfinger and his wife Amy have won a \$75,000 lawsuit against the City of Los Angeles. The Feldmans sued the city in 2003 after police thugs ransacked their home searching for "evidence" relating to a spray-paint attack on the home of the director of L.A.'s miserable animal shelters.



## FELONY CHARGES DROPPED AGAINST DUCK RESCUERS

(New York, USA) In late November, felony burglary charges were dropped against Ryan Shapiro and Sarahjane Blum, two activists with GourmetCruelty.com. Both plead guilty to misdemeanor trespass and received community service. The arrests were a result of an undercover investigation of the Hudson Valley Foie Gras factory farm in Liberty, New York, and the open rescue of injured and suffering ducks from the farm. It was the first time that "open rescue" activists in the U.S. faced criminal charges.



## BRITISH HEN RESCUER NOT GUILTY

(England) British activist Donald Currie has been found not guilty of burglary despite admitting removing 15 hens from an egg farm in the south of England. Police with dogs and a helicopter arrested him near the farm late one night in March 2004. During the trial, Donald explained that the hens had all been found in the waste pits below the cages and that there was rat poison in the pits. Therefore he argued he had acted to save the birds. In what is believed to be the first case of its kind in the UK, the jury agreed that Donald had acted with honest intent and returned a unanimous verdict of not guilty.



## FOIE GRAS - THE NEW VEAL?

direct action helps gets the goods, once again.

(California, USA) In February, the owner of one America's largest foie gras farms (Sonoma Foie Gras, in California) announced the closure of Sonoma Saveurs, a foie gras restaurant and "boutique." Owner Guillermo Gonzalez blamed a lack of customers for its demise.

When the restaurant was under construction in the summer of 2003, a strong message of disapproval was left at the homes of Gonzalez's two business partners with red paint, glass etching cream, paint stripper and glue. A few weeks later, anonymous activists poured concrete into drains at the restaurant, causing over \$50,000 in water damage.

This action was followed by an undercover investigation by the Animal Protection and

Rescue League at Sonoma Foie Gras. The combined actions began a flood of newspaper articles and television reports, both local and nationally.

Despite the predictable accusations by mainstream animal welfare groups that direct action is bad PR, sets back legal methods of social change, etc., last September California Governor Arnold Schwarzenegger signed into law a bill that would ban the force-feeding of ducks and geese to produce foie gras, and its sale statewide. (It should be noted that many activists are critical of the bill, which grants Sonoma Foie Gras immunity from lawsuits and doesn't take effect until 2012.) Several states are currently considering similar laws.



## THERE'S NO PLACE LIKE... CANADA

(Vancouver, Canada) Tre Arrow's extradition hearing has been set to begin June 27 in Vancouver. The U.S. government is seeking his extradition in connection with the destruction of logging trucks and heavy equipment in Oregon in 2001. The main evidence against him is the testimony of a snitch. Tre Arrow has stated, "I am innocent of the charges the US government is trying to pin on me. Just as many activists have experienced, I am being targeted by the US government and the FBI, not because I am guilty, but because I have chosen to challenge the status quo." For more information about Tre's case, visit <http://www.trearrow.org>.

## HERE'S TO THE LUNATICS!

(England) In February, the journal *Science* reported that fear of controversy often determines what and how scientists choose to research. Scientists listed "militant animal rights groups" as a major concern. One scientist explained why he avoided some research, "I would like to lunatic-proof my life as much as possible."

Two cars belonging to an HLS supplier gets the 'royal treatment'.

## COMPANIES AGREE: WE CAN'T HANDLE THE PRESSURE

(England) In a related story, the Association of the British Pharmaceutical Industry reported that in 2004, more businesses than in any year before stopped supplying goods and services to companies engaged in animal research, and 2005 is likely to be worse (better!). The industry group blamed the capitulations on harassing phone calls and damage to property. Interestingly, they also reported that the number of activists who took part in legal street demonstrations had declined.





# SUPPORT PETER YOUNG



*Germany, 09.08.04*



**PETER YOUNG**  
PFN #DVF828  
Booking #05015987  
C/O Santa Clara Main Jail  
Complex  
885 North San Pedro St.  
San Jose, CA 95110  
**Remember, all letters are read by  
the authorities before they are  
turned over to Peter.**

[www.SupportPeter.com](http://www.SupportPeter.com)  
[letters@supportpeter.com](mailto:letters@supportpeter.com)  
(include a mailing address if you  
would like to hear back from Peter)

**P**eter Young needs your help. After seven years on the FBI's most wanted list for allegedly raiding fur farms, Peter was arrested on March 21 in California as a result of dumb luck on the part of police. He is now facing years in prison on charges of Animal Enterprise Terrorism. It is a sad day when allegedly releasing animals into the wild amounts to terrorism.

As we go to press, Peter is being held at the Santa Clara County Jail on local charges unrelated to the fur farm raids. He will ultimately be transferred to Wisconsin, where he will face federal charges.

### Case Background

In October 1997, five fur farms in Wisconsin and surrounding states were raided. Thousands of mink were released, and it is estimated over one million dollars of damage was caused. The raid was never claimed by the Animal Liberation Front.

Peter Young and Justin Samuel were pulled over by police in the vicinity of the farms after suspicious fur farmers contacted authorities. A vehicle search allegedly yielded animal rights literature, as well as other "suspicious" items. In September 1998, a federal grand jury indicted the duo on charges of

animal enterprise terrorism and unlawful interference with interstate commerce.

One year later Justin Samuel was arrested in Belgium and extradited to the United States. Despite an enormous outpouring of support from the activist community, Samuel entered into a plea agreement with the U.S. Attorney's office in which he implicated Peter Young and promised to testify against him at any future trials or hearings. Now Peter could pay the price for Justin Samuel's statements.

### How Can I Help?

#### Write a Letter

Letters are one of the only lifelines to the outside world for prisoners. Please take a few minutes to regularly send letters. Let him know what is happening in the outside world. However, please remember that all letters are read by authorities. Check [www.SupportPeter.com](http://www.SupportPeter.com) for his current mailing address. Letters can also be emailed to [letters@supportpeter.com](mailto:letters@supportpeter.com). They will be printed out regularly and sent to him.

#### Financial Support

As an ethical vegan (and someone who is receiving a lot of mail that needs responses), Peter needs money on his books to purchase food, writing materials, and other necessities. Money orders can be sent to him (please see website for most current information on where/how to send money).

In addition to commissary funds, legal funds are needed. Peter is facing serious federal charges and a lengthy prison sentence, compounded by the added issues caused by snitch Justin Samuel. As a result, he needs the best legal assistance possible to handle his federal case in Wisconsin. Funds for his legal defense and for general support can be sent to:

Peter Young Support Fund  
740A 14<sup>th</sup> St. #237  
San Francisco, CA 94114  
(make payable to: Peter Young Defense Fund)

#### Books

Prison can be a very boring place. Peter has asked that books be sent in to help him pass the time. Check the website for updated information on how to send Peter books.

#### Court Support

Unfortunately, Wisconsin is not a hot bed of activists. While there are some supporters there, more are always need. Get the word out to sympathetic people in the Madison, Wisconsin, area. Supporters—especially at his Wisconsin court dates—will offer a moral boost and show that he is not alone.

Remember, Peter is in there for the animals and the activist community should be there for him.

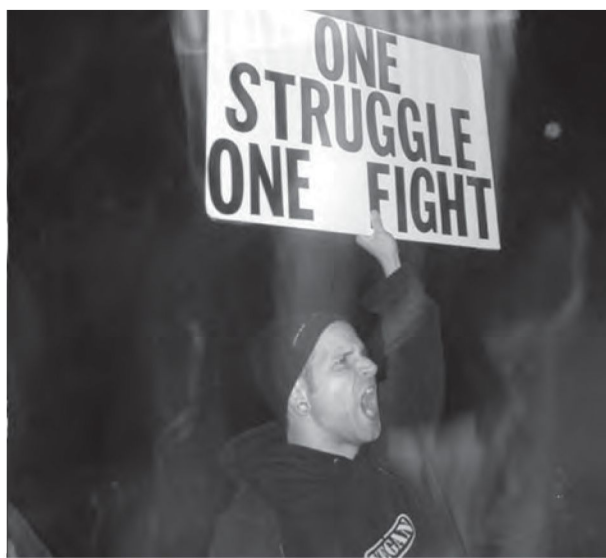

# AGENT *to* AG I

**P**atty Howard is a pillar of activism within the movement for animal rights. As a career activist for countless years, helping to organize marches, rallies, and movement conferences, few would imagine that at one point she stood on the other side of our picket line, with an agency protecting all those 'enterprises' that exploit animals.

Patty is both progressive (she was a leading campaigner for the vegan presidential candidate, Dennis Kucinich) and positive, in that she literally tries to see the best in everyone and to take something constructive from every situation. Below, Patty tries to give a human face to the inhumane actions of the FBI. Although many will disagree with her sentiment, it does serve to show that our opposition, our enemy, are the animal abusers. Officers, agents, and authorities are simply obstacles.



**BITE BACK:** *You worked for the Federal Bureau of Investigation for three years at the J. Edgar Hoover Building in Washington, D.C. What in the world were you thinking?*

**PATTI HOWARD:** Apparently, I wasn't!

Seriously, I come from a family of people in law enforcement. My grandfather was our city's police chief and had graduated from the FBI's National Academy, and my father worked with juvenile offenders, as did I in college. We were a pretty community-minded lot, and for me, law enforcement was all about defending the public against the "bad guys" who would hurt the innocent. I still believe that in most instances that's true. I wanted to feel I was doing something to protect the underdog. Or undercat, if you prefer! I also loved the brain work of investigation — that analytical solving the puzzle thing. Okay, I was a little naive — I admit it!

I took a degree in criminology as well as one in psychology. I was very supported and encouraged by my advisor, a former Berkeley police officer and amateur Egyptologist, although he also encouraged me to not give up my theater avocation. (He must have known something I didn't know!) I had great role models for what law enforcement could and should be. When I graduated, I got accepted to the FBI and planned to do three years of grunt work at the headquarters in Washington, the only other way to qualify as an agent candidate unless you had a law degree

and make it through training, and it's not like you make a lot of money as an agent, so they have to like what they are doing. There was quite a lot of off-putting machismo in many of the agents I encountered, but also many genuinely nice people. I wouldn't say they "always got their crook," though. It became clear to me that most of what they did was time-consuming, methodical, tedious, nose-to-the-grindstone work that may or may not result in an arrest or solution to the case at hand. As to hardworking, they were definitely that. (BB: So are dishwashers).

**BB:** *Now granted, you worked for the FBI before the PATRIOT ACT and this current Orwellian administration, but during your time there what can you say about the scope of their investigative skills? Activists are often worried that they are always watching. Do they have good reason to be this paranoid?*

**PH:** Yes, it's really different now, a whole new climate, so I can't say what it would be like within the Bureau now. When I was there it was pretty impressive what they were able to do as far as uncovering evidence and information, scientifically speaking. I imagine it would boggle the mind now. I started off in the Identification Division (a highpoint was when I got to process the prints of a famous serial killer who had just been arrested), and then was chosen to give tours of the FBI building to Congressional guests, VIP's, and the public. I had to become immersed

*those vindictive agents to those apathetic, or frustrated they are not pursuing real criminals?*

**PH:** I would have to say that's beyond my purview to know if they "care" or not. I don't think there is a vendetta against "animal rights activists" as such. I do think they view any of what they would define as over the top activism as a danger — people who become violent or start fires and things like that.

Overall, the thinking was pretty rigid there. Not much tolerance for individuality. I don't know if that has changed or not. Most of them liked their work, but I suspect that, as with any bureaucracy, there is a level of frustration if there is more you want to be doing and can't, or if you are stuck on some dead-end project or whatever...

We have certainly read in the papers about some pretty horrible things that have happened at the hands of overzealous agents carrying out raids, or whatever. FBI, ATF, all those agencies. I have to put in a plug here for feminism and wonder if these things would not have escalated if more female agents had been involved! Kinder, gentler, whatever ... There are many more women agents now than there were when I was on board. I have to say that, even in my lowly capacity there, at times I observed a "cowboy" attitude among a few of the guys. Again, there were some agents that were more evolved than that — thoughtful and intellectual.

**BB:** *Animal activists often worry that the FBI will exploit internal movement conflicts, much like they did in the 60s with radical groups, but FBI — being composed of humans — likely has its own inner-agency dramas. What did you notice while working there?*

**PH:** You know, they might exploit internal movement conflicts — that is a pretty legitimate tactic that works for them, so I can't imagine they wouldn't try it if they felt like they needed to. It's a possibility we should always be aware of.

As to drama, there were a few while I was there. I remember being demonstrated against by Scientologists who were being investigated. I think they were stockpiling weapons for some reason, and that made the government suspicious, go figure! It was kind of scary trying to get in and out of the building that day. I can understand why people are a little fearful about mobs of demonstrators. If you are on the other end, it can make you somewhat nervous. I still demonstrate for animals, women, and peace, though!

Also someone was rumored to have been fired for being gay. At that time it was a lot more common for that to happen everywhere, but times were changing, and there was a big lunchtime demo in front of the building again. I have to confess I joined in on that one! We never found out if he was really fired for being gay — he may >>>

# TATOR

**A TALK WITH PATTY HOWARD,  
FBI AGENT TO ANIMAL ACTIVISTS**



or an accounting degree. It was pretty thrilling, I have to tell you, to have been accepted by what was considered to be the pinnacle of law enforcement in this country.

**BB:** *Movies, TV shows, and pop culture in general depict FBI agents as these hard-working, crime-hating, genius gumshoes — who always get their crook. Who are they really? What kind of people did you notice become agents, what was their motivation, and are they really intellectually or courageously all that special?*

**PH:** Many of them were pretty special in their abilities. It takes a lot to get accepted to Quantico

in what each separate division did, from intelligence to forensics.

It was fun talking to people on the tours about the early days of the FBI — you know, Al Capone, John Dillinger. I showed them Dillinger's machine gun and a plaster cast of his face and was always asked if we had a plaster cast of a more famous part of his anatomy that apparently was pretty impressive! I never found out if we really did or not, but I sincerely doubt it! I always wondered how that rumor got started ...

**BB:** *Do they care? Do the agents assigned to investigating political causes like the animal rights movement personally care about us or is this just a job? From your observations what is the ratio between*

just have been incompetent, but it was a good time to raise and address these issues.

**BB:** Can you describe the political tone within the FBI? Was John Ashcroft their dream-come-true?

**PH:** At the time there was still a lot of reverence left over for J. Edgar! But I don't know if anyone could have predicted Ashcroft. I can't answer that one! He sure made more work for everyone!

**BB:** What made you finally quit your job there?

**PH:** I got pretty tired of the rigid bureaucracy — it didn't take me long to realize that it didn't fit my personality, although I gave it my best shot. Our private lives could even come under scrutiny. I also saw how hard a time the women ahead of me were having in becoming agents. It seems like they were all judged under more rigorous and unfair standards than the men were. I really questioned if I would even want to live in that regimented box for the rest of my life. The answer was definitely no! I started auditioning for professional theaters in DC and quit as soon as I got a gig that paid as much as I was getting at the FBI (that tells you how badly the FBI paid!). So I am still thanking that wonderful advisor for encouraging me to keep those skills honed as well.

**BB:** Since you've left have you ever had any run-ins with the FBI, as an activist, or worried about retribution since you once worked for them?

**PH:** I have not had any run-ins as an activist, but I always kind of wonder when I see people taking pictures at demos, because I know my prints and everything are all on file. I don't worry at all about "retribution." I pretty much doubt if they keep us on their radar — there are so many employees and former employees. When I worked there, though, it was drummed into us that we

**BB:** What advice can you give animal rights activists today about interactions with federal agents?

**PH:** Only what you all already know. Know what your rights are. I like to come from a place of compassion with everyone, though. I think that puts all our interactions on a higher level and furthers our collective cause. I don't think it should be any different when it comes to law enforcement.

## KNOW WHAT your rights ARE. WE MUST KEEP QUESTIONING AND DEMANDING AN END TO THE PATRIOT ACT INsofar AS IT THREATENS OUR CIVIL RIGHTS.

not talk about anything FBI-related outside of work, so I am a tiny bit nervous talking to you here, but that's just me. This is obviously just a common-sense security rule, like Las Vegas — you know, what happens in the FBI stays in the FBI! I don't think I am sharing anything critical here!

The situation is what it is now with the Patriot Act and it's a phase we just have to get through, tough out, until there is a change of administration and, of course, we must keep questioning and demanding an end to the Patriot Act insofar as it threatens our civil rights. We need to go further in getting mainstream public opinion on our side because, in the end, most people rely on law enforcement to make them feel safe, so federal, state, and local law enforcement officers are more or less carrying out public mandate, however unenlightened that may be at this time. **BB**

In dozens of news articles detailing numerous underground actions in North America, comment has been unavailable to counter the interests of the animal abusers, who have spoken largely unopposed.

### No longer.

The North American Animal Liberation Press Office (NAALPO) was founded in December 2004 to accurately communicate the statements, actions, strategies and philosophy of the animal liberation movement directly to the media and public.

For more information, contact:

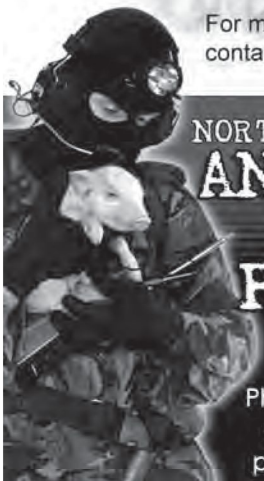

NORTH AMERICAN  
**ANIMAL  
LIBERATION  
PRESS OFFICE**

21044 Sherman Way #211  
Canoga Park, CA 91302

Ph: (818) 932-9997 Fax: (818) 932-9998  
www.AnimalLiberationPressOffice.org  
press@AnimalLiberationPressOffice.org

## the **Vegan Internet solution**



We are a British company providing reliable Internet services to meet the needs of activist groups all around the world. We specialise in **freedom of speech, privacy and anonymity.**

- **Secure and private** web hosting, email accounts and domain registrations.
- Our customers' **privacy** is extremely important. We can help you remain **anonymous** whilst running your site if necessary. Anonymous payment methods are also supported.
- We can provide **offshore hosting** in locations such as Singapore and Hong Kong for sites that are under threat of censorship from oppressive governments and corporations.
- **No monitoring or censorship** of your web sites.
- **Secure and fast servers** running the latest software.

Contact us now for help setting up a new site or moving from another hosting provider.

▶▶▶ [www.kaleton.com](http://www.kaleton.com)

▶▶▶ [info@kaleton.com](mailto:info@kaleton.com)

▶▶▶ Post:  
PO Box 618  
Leeds  
LS4 2WP  
United Kingdom



internet solutions for your business

**KALETON INTERNET**





Sometimes you have to run,  
outsmart them,  
or just laugh.

But one things for sure: they're out to get us.

# THUGS FOR HIRE

Agent to Agitator » pg.10  
Handling Interrogations » pg.13

Boopers, Bobbies & Blunders » pg.14  
Feeling the Jet Blues » pg.17





# HANDLING POLICE INTERROGATIONS



In light of a recent upswing in activist arrests for Earth Liberation Front actions due to snitches, we thought a friendly reminder was in order...

**Rule #1: Keep your fucking mouth shut!**

**Rule #2:** If you ever think of opening your mouth, refer to Rule #1.

Inevitably, at one (or many) point in our activist careers, we'll each face a police or FBI interrogation – be it after an arrest, with the FBI making the rounds and knocking on your door, or with a "friendly" cop at a demonstration, who of course isn't interrogating you – he's just having a friendly chat.

So how should these situations best be dealt with? Simple: keep **your fucking mouth shut**. The reasons for this are simple.

Nearly all A.L.F. and E.L.F. arrests have been the result of those who didn't **keep their fucking mouths shut**. So if you care at all about those individuals who are willing to risk their own freedom for the animals, and if you have an ounce of empathy for the animals who depend on those actions, **keep your fucking mouth shut**. Allow those people to remain free and able to do their good work for the animals.

If you've been involved in an underground action, **keep your fucking mouth shut**. The police will try anything to get you to talk<sup>(1)</sup>, *but nothing you tell them will ever help you, other activists, or the animals*. Not only does opening your mouth put your comrades in danger of being caught, but admitting to your own involvement will still have you rotting in jail – but with no support from the movement. Unless you know you'll be able to **keep your fucking mouth shut**, don't get involved with others in any underground actions. If you know about someone else who's done an action, the first problem is that **someone didn't keep their fucking mouth shut**. Nonetheless, *you should keep your fucking mouth shut*, and not share your knowledge with *anyone*.

Up until a few years ago, the Feds could only complain of the difficulties in identifying and prosecuting the perpetrators of A.L.F. and E.L.F. actions. Unfortunately much has now changed. For whatever unjustifiable reasons, activists who've been involved in underground actions have been admitting to them and turning in their comrades. This only serves to jail more activists, allow the Feds to rant about their "success" in prosecuting "terrorists," and intimidate other activists from getting involved in underground actions.

Even if you *don't* know anything about underground actions, you should still **keep your fucking mouth shut!** The notion that "I don't know anything, so it's better to just be honest," is erroneous. Remember, police and the Feds know *nothing* about our movements unless we tell them. Even if you have no information about illegal actions, the most seemingly innocuous piece of information could be all the "authorities" need to finalize their puzzle.

So remember, **keep your fucking mouth shut!** Police and F.B.I. agents will try and scare you into thinking that you *have* to talk to them and that if you don't, they'll do any number of terrible things to you. But keep your head on. You are not required to speak to the police or the F.B.I. ever. Only a court, by way of a subpoena<sup>(2)</sup>, can force you to talk, and then, only to a court – *never* to the police or the F.B.I.

Remember, they have no interest in helping you; their one and only goal is to find and arrest those responsible for underground actions. If they had all the information they needed, they wouldn't be barking up your tree. So keep your head on, stay calm, and **keep your fucking mouth shut!!**

## footnotes:

1. See:

*"My daughter is a vegetarian."*

*"I agree with your cause, just not your methods."*

*"We're not after you, we want Jane Doe. If you help us, we'll go easy on you."*

*"So...how 'bout those Red Sox..."*

2. If you do receive a subpoena, contact the National Lawyers Guild at 212 679-5100 and ask for referrals to lawyers who can file a motion to quash the subpoena.

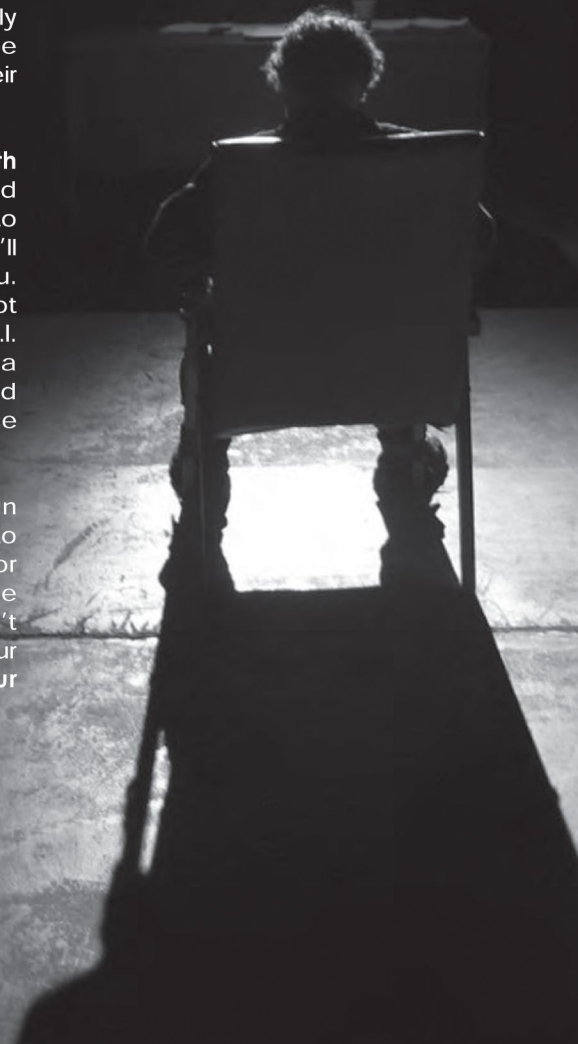





**Ronnie Lee, Keith Mann** and a **couple anonymous friends** share their favorite 'comedies' with the coppers. While British accents may seem funny, their law enforcement is hilarious. These bubble-hat wearing clowns have managed to allow the UK animal rights movement, particularly that of the ALF, to devastate animal-abuse industries across the tiny Island of Great Britain - with few comparative arrests. The following stories illustrate not only how this has been possible, but more importantly for everyone else, why there is so little to be afraid of when contemplating a direct action career. A little courage and a sense of humor is all you need!



### Presents from the Police *Keith Mann*

The Eighties Animal Squad (Animal Rights National Index - ARNI) put together a bulletin to inform and update regional police forces, particularly those with an ALF problem. This was of course a secret internal thing, but very early on in their inception copies of everything fell into my arms, by accident I think. I was at home watching the clock as I had a couple of detectives coming round. This is normally a good reason to be out of the house, but they had made an appointment to return some of the things they'd taken on an earlier visit when they definitely weren't invited. I had been accused of an assault on a hunt and criminal damage to a McDonalds' windows but they decided I was guilty of neither. In the boot of their car were loads of bags of my possessions. Polite half

hearted greetings over, we unloaded their car boot and carried my stuff back indoors. I didn't realise it at the time, but amongst the haul were two large black bags that weren't mine. It was of course nice to have my things back after so long but best of all was to have someone else's! I couldn't believe my eyes when I saw what they'd given me.

Angry Cop had asked of Affable Cop when grabbing the first bag from the boot if everything in there was mine, Affable Cop answered in the affirmative. I had overheard this, but just to be on the safe side I was out of the house in a flash once I'd realised they'd given me a large pile of police surveillance photographs and negatives, files, copies of ARNI circulars and details of operations in the Manchester area. At a friends house we spread out the 'juicy booty' over the kitchen table and feasted!



### Arrested Development *Ronnie Lee*

Three ALF activists were busy breaking into the offices of the British Field Sports Society in London (the BFSS is an organisation that supports and defends hunting and other blood-sports).

The activists saw a police car pull up and hid in a nearby shed. They heard the uniformed police moving about outside and then the words "Right you, you're under arrest, get up against that wall!"

This was followed by cries of outrage from those "arrested", who turned out to be plain clothed detectives, who'd arrived on the scene at the same time, but from a different direction.

The activists were still in fits of laughter when they were eventually discovered in the shed and taken to the local police station. Sadly, they were later sentenced to several months' imprisonment, but had the hilarious memory of that night to sustain them through it.

by "Someone called Dave". Dave was my mate who wasn't called Dave and Dave had been shopping for food items that might allow someone to secrete a hacksaw blade and or screwdriver, down the inner edge of a carton of juice for example.

Linda had built a large enclosure for Mitch outside her window, but the squirrel preferred to spend her time perched on top of a tall cupboard in Linda's kitchen.



## Love at First Fart

*Anonymous UK activist*

We had not long met and I thought this could be the one for me...

Vans were arriving in their masses and demonstrators were heading down the winding country lane that lead to Guilders, dealers in animal exports. The demonstration had gone on there after a charged and highly successful demonstration at Consort (dog breeders for the vivisection industry, now closed down) The police were expecting us and had formed a line across the lane, before people could pass they had to give their details and be searched. We had all spread out in our attempts to evade them. He was just ahead of me.

They stopped him and started to pat along his arms, check round his waistband and then crouch down and pat his trouser legs. It was at this point, with the coppers head in perfect alignment, I heard what can only be described as a loud fart followed by the police man saying "Thanks for that." I knew at that point it was true love."



## Tools, Tunnels, and 'Todgers'

*Keith Mann*

...With the help of the same friend who was on call to assist me in my (prior) non-escape, I ended up with the tools my cellmate Dean and I needed to dig our way out. This was one of those police stations for very green county bumpkins with no idea of the rules of the jungle. Most of them (the police) were nice enough, but not meant to be in charge of tricky customers (AR activists) who wanted to be 'elsewhere'. There wasn't much crime in the locality and there were just a few cells in the cellblock. We were allowed to have food brought in from outside to

(the copper) had just unknowingly given me a box containing not one, but three carbide hacksaw blades and two screwdriver shafts.

supplement the menu and sometimes the duty officer didn't even bother to check it. Amongst the munchies we'd have Bacardi in the coke and hash in the dried fruit handed to us by the police! There was, it has to be said, a good atmosphere and no risk of a riot - but for security reasons this is clearly not good.

One night I was handed a box of such goodies, goodies that had been delivered to the front desk

In the sturdy vegetable box of goodies the fat greasy copper handed me were 'treats galore' including the means to put to test an escape plan. The fat greasy copper incidentally used to sit in the corridor outside the shower cubicle, arms folded, and watch prisoners come and go in hand towels. Others, when on duty, would sit facing the television, not at all interested in wet semi naked men. He was though, and he wasn't fussed who knew it. He was not someone you warm to, but he had just unknowingly given me a box containing not one, but three carbide hacksaw blades and two screwdriver shafts and I didn't care a toss if he'd looked at my 'todger'. The tools were pushed evenly spaced into the corrugated lining of the box, which was itself full of vegan goodies.

My cellmate told me he was a car thief (I later found out different), but he was a nice enough bloke on the face of it and someone I was happy to escape with. We had loads to eat, something to drink, and the makings of a way out. Things were looking up! We had a good night in! (Note: Unsuccessful, but in no due part to the ineptness of the local police.)



## Operation Bite Back

*Ronnie Lee*

In 1975 while I was serving a prison sentence for animal liberation activities, some activists set fire to a pork pie factory and told the media that one of the reasons they'd done this was in protest of my imprisonment.

The prison kept records of people who had written to me and the police immediately set out to question everyone on the list.

One of these was a friend of mine called Linda who ran a fundraising shop for an anti-vivisection

society and lived in North London with a squirrel called Mitch.

Linda had rescued Mitch from a gang of youths who were using the squirrel as a football, but she could not be released back into the wild as she had sustained serious injuries to her jaw which meant her teeth didn't meet properly and she had to be taken to the vet regularly to have them trimmed.

When the police burst through Linda's door, Mitch came hurtling down from the top of the cupboard and attacked them, sinking her teeth into the chief detective's thumb. His colleagues had to rush him, in a state of shock, for treatment at the local hospital and their questioning of Linda was postponed to another time.

The activists who torched the pork pie factory were never caught.



## Smile, You're on Candid Camera

*from Summer 1998 issue of the UK ALF Supporters Group Newsletter*

Several years ago, a group of activists sharing a home in England had a curious run-in with police surveillance.

The fun began when the area was being wired for a new television frequency, and their neighbors mentioned something odd. An image of the activist's house had appeared, very faintly, on their TV screens. Working from the image on the screen, the activists were able to find a small camera inside a nearby house. Over the next few days, they checked the entire neighborhood and, in a building owned by the local water company, activists discovered a microwave receiver, coaxial cables, a power supply, a slow record video machine and a TV screen. They began monitoring the activity surrounding the building. For several weeks, once a day, a plainclothes police officer in an unmarked car visited the building and changed the videocassette.

Eventually the novelty of being actors in a police movie wore off, and the activists decided to remove the equipment. Upon closer examination,



they found all of the equipment was inscribed "Tactical Support Group No. 4."

A suitable message, "A.L.F. Watching You Watching Us," was left at the scene. As for the equipment, it was put to good use, safe and out of the hands of the police "bungle-squad." BB





# Feeling Unsafe in a Post-9/11 World??

## DON'T WORRY. YOUR GOVERNMENT HAS THE TERRORISTS MARKED!!

how you're ID is making you guilty before proven innocent.

Have officers approached you with guns drawn after pulling you over for a traffic violation?

Are you detained for hours every time you re-enter the country?

Have you had FBI agents knocking on your door in response to a letter you sent to a pharmaceutical company?

If you answered 'yes' to any of the above questions, you may be a terrorist.

An absurd phenomenon has swept the activist community since the terrorist attacks of September 11, 2001. Animal rights and environmental activists have found themselves on an FBI "terrorist" list. These activists are primarily individuals who have

Specifically, you are an "animal rights/environmental extremist." The officer is advised to contact the F.B.I., but not to arrest you unless there is evidence that you have committed a state, local, or federal crime. It also warns the officer not to inform the individual that the warning is present.

Practically, it means a longer wait when going through U.S. customs, facing guns when you've gone 10 mph over the speed limit, and the usual general harassment from the police and the F.B.I.

In a broader sense, this list means yet another dilution of our freedom to associate. Another intrusion into the rights and the lives of those who would dare oppose the most powerful government – itself bought and sold by the most powerful corporations – in the world. And, it means a more vulnerable world, where the agencies entrusted

### WHEN WE ARE ALL TERRORISTS, NO ONE IS A TERRORIST.

never even been *charged with*, let alone convicted of, a misdemeanor – much less a felony.

That's right. They've never been arrested for vandalism, have never been accused of liberating animals, never spiked trees or burned a fur farm to the ground. Why then are these people "terrorists," according to the FBI? Answer: Because they've expressed support for animal rights and environmental campaigns (i.e. the SHAC campaign).

That's right folks! These days, showing up for a demonstration, locking down to a fur store, and running a website can win you the top title of Terrorist!

*What does it mean?*

So what does it mean to be among the selected many? Whenever an officer runs your license (or other I.D., such as a passport), a warning flashes on the screen advising the officer that you are a member of a terrorist organization.

with protecting U.S. citizens from further terrorist attacks equate those who blockade the doors of fur stores with those who fly planes into buildings.

*What can you do?*

Well there's no number you can call, no list you can ask to be removed from – no "do not terrorize" register for this sort of marketing. But you can keep doing what got you on the list in the first place – agitate, aggravate, and associate. Stand up for your own rights by exercising them. Every protest for the earth and the animals is also a protest for you, and all those like you who dare to fight for what's right.

By failing to be intimidated, you can help undermine these efforts. By spreading the word, you can expose their secret list, and the crooked blacklisting of activists for which the F.B.I. is infamous. And, of course, recruit others for the ongoing struggle for the earth and the animals. When we are all terrorists, no one is a terrorist.

Travel. Crime. Militant Unemployment.

# EVASION

New book - Fall 2005

NEW EVASION ZINES

**Evasion Zine #1 Reissue** - Original, handwritten zine from 1999, that would go on to comprise 40% of the Crimethinc book. Contains the almost famous "lost Evasion material" - 10 pages cut for the book, including 6 pages of scams. Back in print for the first time in years. Revised layout w/new "history of" insert. Full size, 108 pgs. \$2ppd

**Evasion zine #2** - All new handwritten zine version of the Evasion book-only material, with added graphics, commentary, intro/outro material, and cut-and-paste personality a typed book can never offer. The Crimethinc book as it was meant to be seen. Stories you may or may not have read - coming to life, maybe for the first time. 120+ pgs. \*NEW! \$2ppd

**Evasion #2.9** The Summer Supplement. Part one subtitled "Outtakes and Rarities." Part II: First draft excerpts from the upcoming Evasion - Book II. Pre-rewrite, pre-not-sucking. Full size, handwritten, 26 pgs. \$2 ppd

www.xevasionx.com    evasion@crimethinc.com

Evasion. / 245-M Mt Herman Rd / PMB#124 / Scotts Valley, CA 95066

Shirts (AVAILABLE IN BLACK OR WHITE. SIZE S/M/L/XL). Evasion "Vegan" design. Evasion "Shopping Is Not A Crime" design. \$7 ppd. MISC. Universal Handoff Key \$2 ppd. Technology of Burger Alarms' report. 130 pgs. \$4 ppd. Next: New Evasion book, "Suburban Jihad" documentary. Evasion #2.5 100 pg. Supplement (Scientific advice). Vegan sXe Retrospective zine. More: www.xevasionx.com for more. Unemployed Vegan Straight Edge xxx Mack Evasion

# species traitor

an insurrectionary anarcho-primitivist journal



## issue 4 out soon

Over 200 pages, book bound with focuses on the consequences of domestication and agriculture, resisting civilization, rewilding our lives, questions on animal rights versus animal liberation.

Out summer 2005, taking pre-orders now. For more info:

Species Traitor  
PO Box 835  
Greensburg, PA 15601 US  
coalitionagainstcivilization.org



# FEELING THE JET BLUES

*why you're not flying home for the holidays*

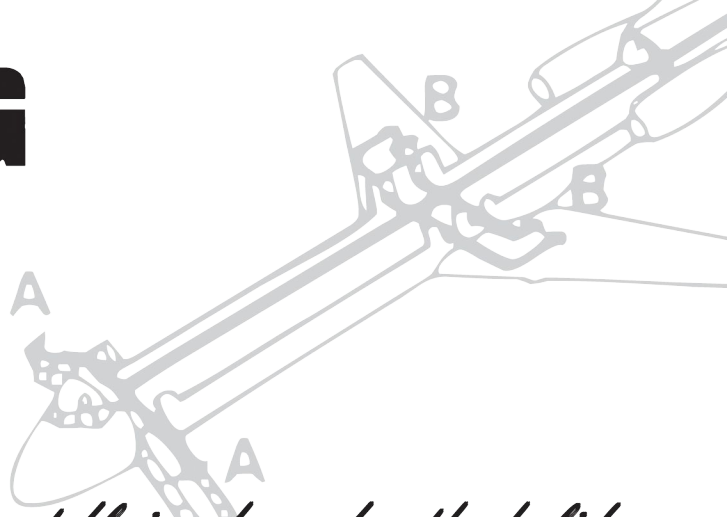

## ACTIVISTS, AVIATION, AND ANGST

What do Ted Kennedy, Cat Stevens, the Peace Action of Wisconsin, and the Center for Constitutional

Rights now have in common with a growing number of animal rights activists? All are finding it increasingly hard to board a plane, if allowed to travel at all.

As corporations go multinational, world governmental bodies meet in remote locations, and the importance of mass public mobilization is again on the rise – a potent tool of suppression at the government’s disposal is that which limits activists’ access to transportation.

‘No-Fly Lists’ are the 21<sup>st</sup> century extensions of the 1960’s private bus company ‘black-lists’ of passengers that were civil rights workers and ‘freedom-riders’ traveling into Mississippi to register black voters. Just as the Supreme Court held this sort of travel ban to be unconstitutional then, the American Civil Liberties Union today is suing the Transportation Security Agency (TSA) and the FBI to force them to divulge how and who maintains these modern travel ‘blacklists.’

Since September 2001 the no-fly list has grown from 300 (only two of the 9-11 hijackers were on it, and were removed on Sept. 12 to avoid agency embarrassment) to today where the San Francisco airport detained 338 persons alone in the year. Accountability for maintenance of the list and how people are added and removed remains murky at best. The FBI and the TSA are currently playing a game of “who’s on first” in answering lawsuit subpoenas, each claiming the other is the authority, so much so that a Federal judge recently admonished both for such a blanket and absurd refusal to turn over the mandated answers and information.

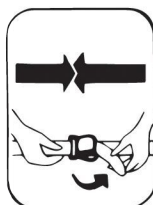

## BUCKLE UP

Animal rights activists popped up on this new radar screen in late 2004 with the first two reported airline detentions and ‘no-fly list’ notifications. While re-entering the US has been a nightmare for many known animal advocates

due in large part to the FBI database VGTOF (Violent Gang and Terrorist Organization File) that today includes animal rights and environmental activists, no one had ever been prevented from flying until this point.

A Seattle animal activist, who by day works as a CPA, was prevented from flying home to New Jersey for Christmas because of her new inclusion on a federal no-fly list. She had flown dozens of times since the 9-11 change in aviation protocols,

was detained, interrogated, his bags were emptied, and he was strip-searched before finally being allowed to board a flight hours after he was supposed to have departed. In this case the TSA officials noted the FBI was involved and his name likely placed on the list because of current political charges he is fighting (so much for innocent until proven guilty).



## EXPECTED TURBULENCE

While only two animal rights activists have been notified of their transportation troubles thus far, more are to be expected. If a liberal US Senator and anti-war activists that include nuns, priests, and Quakers are ‘radical’ enough to be classified as dangerous, it does not

**SINCE SEPTEMBER 2001 THE NO-FLY LIST HAS GROWN FROM 300 TO TODAY WHERE THE SAN FRANCISCO AIRPORT DETAINED 338 PERSONS ALONE IN THE YEAR.**

but not since she had defied a Federal Grand Jury subpoena ordering her to testify about an ALF action that had taken place 7 years prior in which 200 chickens were taken. The Grand Jury was a flop, the Federal Prosecutor in charge was demoted, and no “crime” was solved. The woman’s sudden status as a ‘danger and threat to aviation’ safety seems more than suspect. Her experience and complaint has been added to the ACLU lawsuit.

In March of 2005 an animal rights activist on the other side of the country was stopped at JFK and prevented from boarding his domestic flight for hours. Although polite, the TSA officers told him his name was showing up on the no-fly list. He

take much for the government to feel ‘threatened’ these days.

More troubling still is the prospect for what is to come beyond the no-fly list. A permanent blacklist is currently being proposed by the TSA that will screen each passenger as they are buying their tickets. Airlines will be required to check with law enforcement agencies and intelligence and credit databases. Everyone will be assigned a risk factor “score”. A green score denotes easy passage, yellow requiring a more thorough pre-boarding screening, and red barring you from any flight. Those determining the score attached to each passenger will continue to be colored by the political bias of the FBI.





# THE SHAC7



Talking Tactics, an interview with the FBI » pg.19  
The SHAC7 and Me by defendant Josh Harper » pg.22  
Protect Yourself, SHAC Style » pg.24

As the underground movment delivers some much needed justice, the above ground activists are dismantling animal abuse piece by piece. The SHAC7 case, if anything, has highlighted just how badly the FBI wants this to end.

Take a look at just how they are trying and what you can do to protect yourself.

Without an interview with Kevin Jonas.



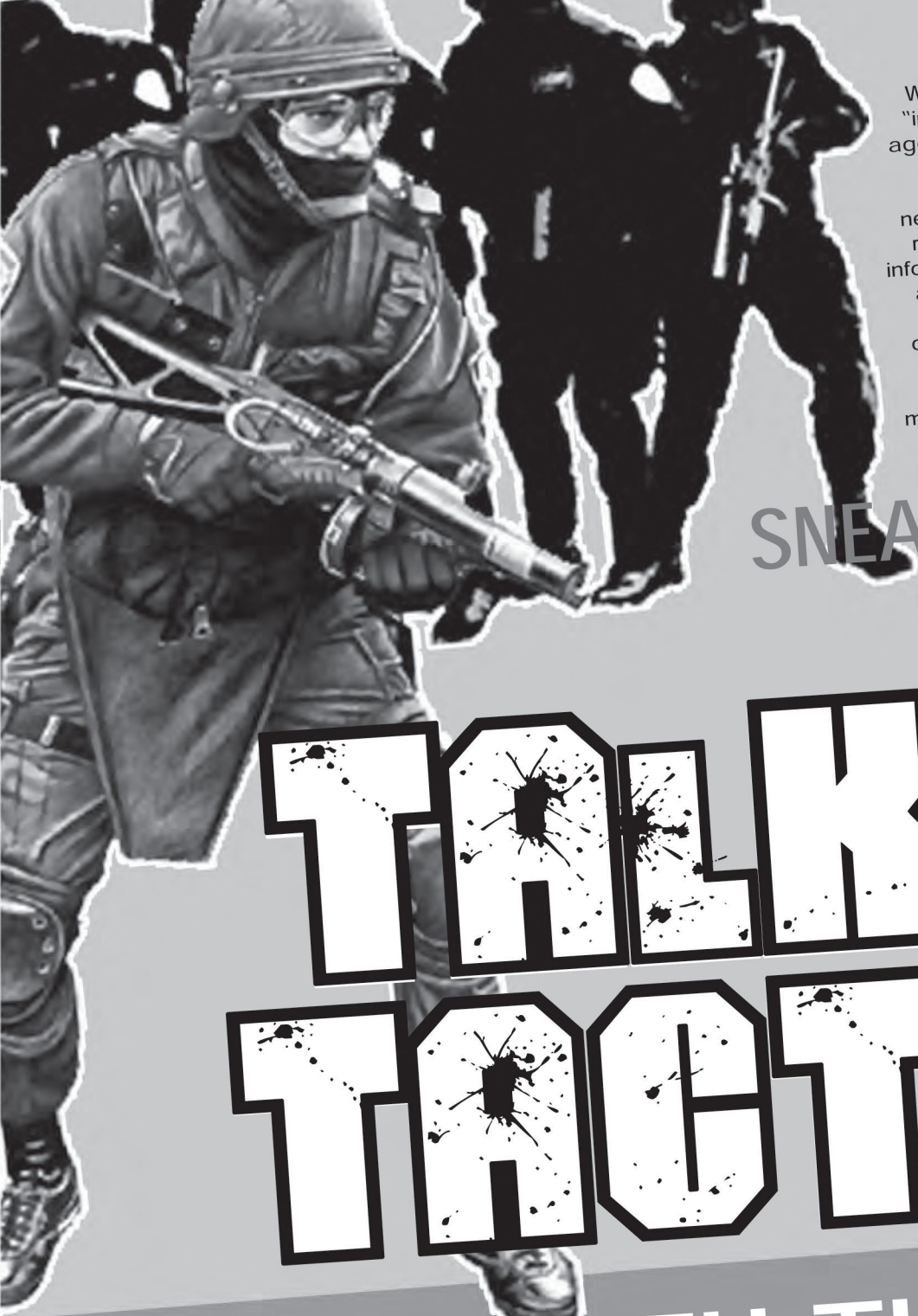

What follows is a rare and candid "interview" with one of the key FBI agents involved in the investigation of the SHAC campaign. The information revealed was likely never meant to be read by animal rights activists and contains useful information on the agency's abilities and what confounds them. Taken from their very own affidavits to obtain electronic, telephonic, and search warrants the answers to these questions help today's modern direct action activist 'know thy enemy.'

# A SNEAK AND PEAK INTERVIEW

# TALKING TARGETS WITH THE F.B.I.

**BITE BACK:** Please identify yourself.

**FBI:** I am a special agent of the Federal Bureau of Investigation (FBI), United States Department of Justice, and have been so employed for approximately seven years three months. I am presently assigned to the Minneapolis Office of the FBI, specifically to the Counterterrorism Squad, Domestic Terrorism, Joint Terrorism Task Force. I have worked on terrorism investigations since August, 2001.

**BB:** You worked on terrorism investigations since August of 2001?! Well, good job – since that point I am sure America has been safe. Have you been involved in any other "successful" FBI campaigns besides this 'war on terror.'

**FBI:** Prior to being assigned to the Counterterrorism Squad, I worked on Federal narcotics investigations from March, 1997.

**BB:** Ah, the 'war on drugs' – another bang up job! But why this new zealous and vicious interest in those compassionately working to save animals?

**FBI:** The animal rights movement has evolved from peaceful, legal demonstrations and the occasional unauthorized commercial animal release to a pattern of sophisticated, multi-million dollar property attacks, aggressive protests, harassment, intimidation, extortion, and arson. The primary group responsible for this change is the A.L.F. »





# FBI Special Agents (reported) that Marsh is spending approximately two million dollars per month on added security and other measures due to SHAC actions against them.

**BB:** Really, tell us what you know about the ALF?

**FBI:** The A.L.F. is a violent, underground terrorist organization consisting of small, semi-autonomous cells all over the world whose members use illegal, direct action, such as vandalism and fire bombings, to inflict economic damage... Members of the Animal Liberation Front act directly to stop animal suffering; at the risk of losing their own freedom... due to the illegal nature of the ALF activities, activists work anonymously, and there is no formal organization to the ALF... On February 12, 2002, James F. Jarboe, Domestic Terrorism Section Chief, Counterterrorism Division, FBI, gave a statement to the House Resources Committee... "The FBI estimates that the ALF/ELF have committed more than six hundred criminal acts in the United States since 1996, resulting in damages in excess of forty-three million dollars."

**BB:** But your testimony here is in relation to Stop Huntingdon Animal Cruelty. Where do they come in?

**FBI:** A newer, more focused sub-group in the animal rights movement is known as Stop Huntingdon Animal Cruelty, or simply SHAC. The SHAC newsletter, along with known information about some of the SHAC organizers... indicates that members of SHAC are openly members of the ALF as well.

**BB:** What? Did you not just report the ALF is anonymous and a terrorist organization? Why would you not just arrest them then? That's rather inconsistent; this is really just about that forty-three million dollar figure isn't it? Can you give us an example of how SHAC is causing economic damage?

**FBI:** Marsh USA is an insurance broker for HLS. (Marsh has since abandoned HLS as their

*insurance broker - Ed.*) Executives have reported to other FBI Special Agents that Marsh is spending approximately two million dollars per month on added security and other measures due to SHAC actions against them. Marsh reportedly only profits approximately one hundred thousand dollars per year on its business with HLS...

**BB:** Marsh sounds ridiculous, and conducts poor business. Can you familiarize our readers with the type of protest activity that Marsh experienced in your Minnesota jurisdiction?

**FBI:** It was confirmed by your Affiant that at least one of the four Marsh offices in Minneapolis did receive unwanted email during the internet attack. The four Marsh offices in the Minneapolis area have received unwanted gift baskets containing animal free products and information about animal torture at HLS, and have had at least two SHAC protests at their offices.

**BB:** My god, SHAC really is a terrorist organization! Tell us what the FBI has learned from physical surveillance?

**FBI:** Physical surveillance of the subjects identified has been attempted during the investigation with limited success. Surveillance of the SHAC House... has been of limited success due to the physical location of the SHAC house on a residential, one way street and the fact that the subjects are surveillance conscious.

**BB:** Hmm, so staring at their house didn't lead to any breakthroughs. What about following them?

**FBI:** FBI Special Agents in Newark reported negative attempts to surveil SHAC activists and reported that the activists used the following evasive driving techniques: doubling back; u-turns; pulling over on busy highways/roadways to allow other vehicles to pass; traveling very slow

in the fast lane; pulling into parking lots and getting out of the car, then taking off again; dropping people off at locations with one car and then having another pick up the same person; utilizing rental cars; driving multiple cars in many locations, then meeting again.

**BB:** So these grassroots activists managed to outmaneuver the professionals of the FBI? Impressive! Have you used your PATRIOT ACT to get the phone records of your targets (using Pen Register recording technology)?

**FBI:** During the course of this investigation, pen registers have been and are currently being used... Telephone records alone, however, will not likely result in any successful prosecution of these individuals... Pen registers and toll record analysis does not identify those actually making and receiving telephonic communications, nor more importantly, does it reveal the nature and substance of these communications.

**BB:** So Watching, trailing, and combing through their phone records proves no criminal wrong-doing, I'll bet its time for the FBI to get its hands dirty, right?

**FBI:** Trash searches have been attempted at the 'SHAC' house approximately ten times. The searches executed to date produce negative results... None of these trash searches produced prosecutable results.

**BB:** Okay... That's not really what we meant by getting dirty, but fair enough. What about the metaphorically dirty tricks of the FBI like ColnTelPro? Are you putting undercover agents in, have any paid informants, etc?

**FBI:** There exists a profound lack of witnesses to the direct actions perpetrated by the animal rights activists... There are few informants or

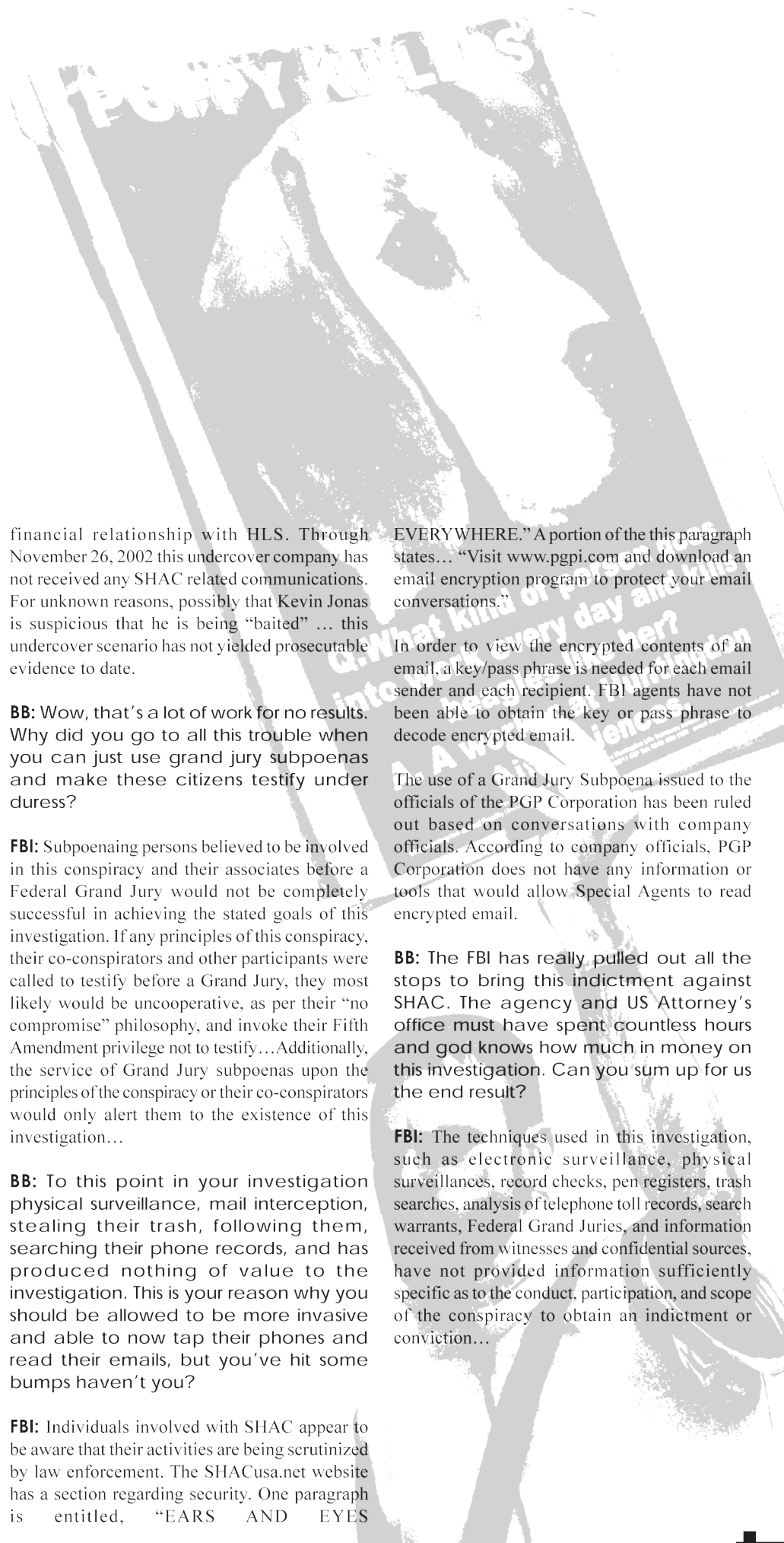

cooperating witnesses involved in domestic terrorism offenses. The animal rights activists adhere to a “no compromise” philosophy, thus making cooperating with law enforcement very rare... As a part of the philosophy, the activists who commit direct actions, particularly violent felonies, do not speak about these actions to anyone outside the small group of individuals who committed the action.

There are, however, a few confidential informants handled by FBI Special Agents in other divisions. Your affiant has been privy to some of their information, however, most of the information has been general in nature. Your affiant views some of these informants as suspect because if they are in a trusted and high level position within the animal rights movement, and have provided no specific information as to who as committed violent direct actions or provided information so as to prevent violent direct actions, their cooperation is suspect or demonstrates their limited knowledge of the scope of the conspiracy.

**BB:** Yeah, we are kind of proud of that. What about those classic FBI undercover operations though?

**FBI:** The use of undercover officers has recently been attempted...The undercover officer is a Minneapolis Police Department officer. The undercover officer has recently been attending the Student Organization for Animal Rights weekly meetings... and the weekly meeting of Compassionate Action for Animals in Minneapolis...Operationally, the undercover officer will likely never be in a position to directly participate in any violent felonies, thus never being privy to first hand knowledge of the conspiracy.

**BB:** Did you try for any 'stings'?

**FBI:** An undercover agent was also used as the incorporator of a business that had a purported

financial relationship with HLS. Through November 26, 2002 this undercover company has not received any SHAC related communications. For unknown reasons, possibly that Kevin Jonas is suspicious that he is being “baited” ... this undercover scenario has not yielded prosecutable evidence to date.

**BB:** Wow, that’s a lot of work for no results. Why did you go to all this trouble when you can just use grand jury subpoenas and make these citizens testify under duress?

**FBI:** Subpoenaing persons believed to be involved in this conspiracy and their associates before a Federal Grand Jury would not be completely successful in achieving the stated goals of this investigation. If any principles of this conspiracy, their co-conspirators and other participants were called to testify before a Grand Jury, they most likely would be uncooperative, as per their “no compromise” philosophy, and invoke their Fifth Amendment privilege not to testify...Additionally, the service of Grand Jury subpoenas upon the principles of the conspiracy or their co-conspirators would only alert them to the existence of this investigation...

**BB:** To this point in your investigation physical surveillance, mail interception, stealing their trash, following them, searching their phone records, and has produced nothing of value to the investigation. This is your reason why you should be allowed to be more invasive and able to now tap their phones and read their emails, but you’ve hit some bumps haven’t you?

**FBI:** Individuals involved with SHAC appear to be aware that their activities are being scrutinized by law enforcement. The SHACusa.net website has a section regarding security. One paragraph is entitled, “EARS AND EYES

EVERYWHERE.” A portion of this paragraph states... “Visit [www.pgpi.com](http://www.pgpi.com) and download an email encryption program to protect your email conversations.”

In order to view the encrypted contents of an email, a key/pass phrase is needed for each email sender and each recipient. FBI agents have not been able to obtain the key or pass phrase to decode encrypted email.

The use of a Grand Jury Subpoena issued to the officials of the PGP Corporation has been ruled out based on conversations with company officials. According to company officials, PGP Corporation does not have any information or tools that would allow Special Agents to read encrypted email.

**BB:** The FBI has really pulled out all the stops to bring this indictment against SHAC. The agency and US Attorney’s office must have spent countless hours and god knows how much in money on this investigation. Can you sum up for us the end result?

**FBI:** The techniques used in this investigation, such as electronic surveillance, physical surveillances, record checks, pen registers, trash searches, analysis of telephone toll records, search warrants, Federal Grand Juries, and information received from witnesses and confidential sources, have not provided information sufficiently specific as to the conduct, participation, and scope of the conspiracy to obtain an indictment or conviction...



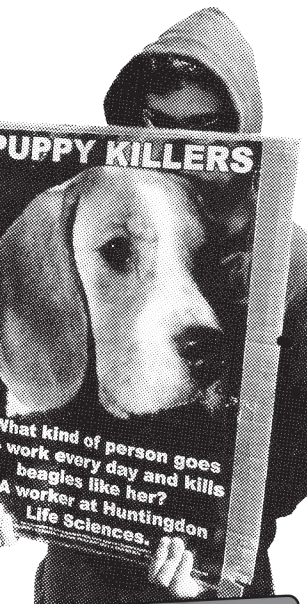

# THE SWAG

AND ME

BY JOSH HARPER  
SHACZ DEFENDANT



Josh is from the Pacific Northwest. He is a former drama school student who now runs his own video production company. Josh has made featurettes on animal and earth protection issues, is a vocal supporter of anti-war efforts, and speaks at universities across the country about current political topics.

Steve Best recently wrote an article detailing a series of epiphanies he had on his path to become vegan. It got me thinking about the small moments in time when the obfuscation of the media disappears, our own bias melts away, and suddenly we can see with absolute clarity the previously shrouded injustice that exists right before our eyes.



A simple trip to the store ten years ago changed my life forever. I had just turned vegan and although I had seen videos and photos of animal abuse I had not yet recognized the totality of violence endured by our fellow creatures. That was all about to change though as I wound my way through the aisles of my local super market. I was headed to the "nutrition center," a tiny alcove in the back of the store that carried soy milk, tofu, and other staples of my new diet. I had just come from my job at a local parking garage, and was pre-occupied with the frustrations of working in a glass booth all day. Suddenly it

holocaust, but who also physically attack the anthropocentric system when they are able. I have traveled all over the country agitating for animals and have spoken to thousands of people. Speciesism runs deep, so my words are controversial, but as an American citizen I have a constitutionally guaranteed right to freedom of speech. At least, that's what I had always been told. On May 26<sup>th</sup> of last year I was arrested on a federal indictment for terrorism charges. My crime? Speaking and writing about my opinions. Welcome to my new waking nightmare...

been stolen, and after all of this time and effort the government had only one "illegal" action they could pin on me; a speech I had made at the University of Washington. An agent in the audience was wired and had recorded me explaining how to send black sheets of paper to companies supporting Huntingdon Life Sciences. No proof exists that I have ever sent these so-called "black faxes" myself, or that anyone who heard me speak that night sent black faxes, but U.S. Attorney Charles McKenna feels that my words alone make me more of a terrorist than the FBI agents who barged into my home and held guns to my room mates heads. It's laughable really, because who runs frightened from black sheets of paper being printed by a fax machine? Apparently just the cry-baby, freedom hating, animal killing scum bags who give HLS their business.

Some of us are facing as much as 25 years in prison, and yet we have not bombed nor beaten anyone. What we have done is stand strong in the face of government repression and fight for animals lives.

occurred to me that I was heading down the wrong aisle. I looked up and realized that I was near the meat case. My eyes locked on a cellophaned package of hamburger meat, but my brain registered something else. A dead cow, mutilated, shredded. I imagined her pushed through the doors of the slaughter house, hoisted up by one ankle, and rotated through the horror of the abattoir. I looked away, not wanting to view this atrocity exhibit, but my eyes swept across leather coats, children eagerly clutching ice cream, racks of animal-tested cosmetics. All of these things had fallen under my gaze in the past, but for some reason I now saw them clearly. They were each a stolen part of someone else's life and body. A piece of their flesh torn away from them, a life in a cage, an existence spent without sunlight or fresh air or companionship. My fellow shoppers just plodded right on past me, sleepwalking through the nightmare I had just woken into.

In the ten years since then I have tried a number of different tactics to wake people up to the horrible reality of animal slavery. Each and every day all across the globe animals are subjected to the worst of humiliations and tortures, and our entire civilization is built upon their suffering. The animal nations deserve advocates who not only tell the world about this ongoing

It is difficult to describe what it is like to be facing charges for "conspiracy to commit animal enterprises terrorism." Sure, I was aware of the existence of the Department of Homeland Security before they knocked on my door. I knew all about the FBI and had previous dealings with them that told me with absolute certainty they exist mostly as a private security force for the rich. I have read extensively about the powers U.S. corporations have to see their will carried out in the court rooms. But reading about these things did not prepare me for seeing my image on a television screen alongside the words, "accused terrorist." I had no idea what it was like to walk down the hall to my apartment and have my neighbors peak from behind their blinds, scared of the "extremist" living in their midst.

Being labeled a terrorist by our government was surreal enough, but as I began to see the "evidence" in the case the idea that anyone has been terrorized became more and more absurd. The FBI had used my mailman to write down all return addresses for items shipped to my home. They had attempted to get one of my room mates to spy on me, and had successfully convinced a longtime activist and friend of mine to spend three years giving them detailed reports on my day to day life. My e-mail and phone conversations had been monitored, my home had been broken into, my personal belongings had

Many of you have heard by now about the SHAC 7 trial. For a moment I want you to forget about the "SHAC 7" and instead think of John McGee, Darius Fulmer, Jake Conroy, Lauren Gazzola, Andy Stepanian, Kevin Jonas, and myself. Each of us are like you; activists trying to make the world a better place with what few means we have at our disposal. We are being tried for our words and our thoughts, for articles, speaking engagements, and postings on websites. Some of us are facing as much as 25 years in prison, and yet we have not bombed nor beaten anyone. What we have done is stand strong in the face of government repression and fight for animals lives. We have struggled alongside many of you and given our most for this movement. Now it is time to stand with us or potentially fall with us. The government certainly sees things that way, federal agents have been visiting a range of activists lately, from mainstream groups like PeTA to individual activists who have never done anything other than write polite letters to animal abusers. If they win this case it is only a matter of time before others among us face felonies for believing that animals have rights.

Trial is approaching fast, and we need your support. Please, hold a benefit in your town for the SHAC 7, print leaflets from the [www.shac7.com](http://www.shac7.com) site and raise awareness of the case. If you are able, please try to make it to New Jersey to show your support during the trial. Or show your support in the manner my co-defendants and I would most like to see- continue attacking the machinery of speciesism and government repression so that we can destroy these parallel nightmares once and for all. Bg

KEEP UP AT: SHAC7.com

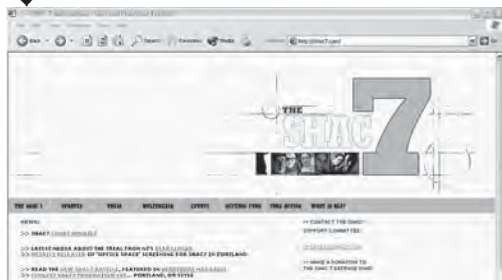





While PeTA is known for its celebrities and the Humane Society for its obscene salaries, the Stop Huntingdon Animal Cruelty campaign is infamous for its security SOPs (standard operating procedures). The SHAC campaign has pioneered, pushed, and made priority the development of a culture where-in ‘nobody talks, and everybody walks.’

As evidenced through the FBI interview, agents got grumpy as activists got clever. The SHAC campaign offers the following security 101 from three years experience of surveillance, raids, criminal cases, and grand juries. Whether you are an activist, a masked superhero, an organization, or a James Bond novice, the following protocols are time-tested and police-hated. Adopt. Agitate. Enjoy.

### 1. PGP

You need not be a ‘hacktivist’ or ‘cyber saboteur’ to appreciate the importance computers and the internet plays in agitation. Like any great boon however, modern technology can also be an activist bane. Your PC records literally every thing you do. Every website you visit, email you send, word document you create, and instant messenger conversation you engage in is marked, dated, and filed in the computers memory. Simply deleting files only erases the visible file or folder from your desktop view, but not the computer’s memory.

PGP (Pretty Good Privacy) is a free, open source (no hidden backdoors for the government to circumvent) software that encrypts emails, files, documents, and even whole partitions. The software generates two sets of ‘keys’ for each user, one that is private that you store on a disk separate from your PC, and one that is public you share with those wishing to send you secure messages. By selecting your key, they transform the email in a solid block of undecipherable string of letters and numbers that only you can decrypt with your private key and a personal password.

PGP also offers a feature that ‘wipes’ selected documents and all the ‘free space’ on your computer. The wipe feature completely erases your documents and all the previous projects you have just simply deleted by going over it and permanently removing it from the hard drive. The FBI seized 7 computers from the SHAC ‘office’ and had a leading technology firm in Washington DC work seven months on trying to crack the

encryption software and came up with nothing. Despite subpoenaing PGP Corp executives and spending endless hours and resources the agency came to the conclusion that it is beyond their means to break the ‘SHAC’ computers. The software can be downloaded at [www.pgpi.com](http://www.pgpi.com) {visual of govt computer report}

### 2. BLAND JURIES

There is nothing a grand jury hates more than a spotlight. These secretive panels are a prosecutor’s source of power, and shy away from public scrutiny (and for good reason). The famous joke about grand juries is that they can be used to indict a ham sandwich because they only hear what gossip, innuendo, and phony evidence the US attorney brings before it. Those subpoenaed can be stripped of their First and Fifth amendment protections, are not allowed an attorney present and can be imprisoned until they will answer whatever question is posed to them, no matter how personal and private.

SHAC has had the opportunity to stare down several grand juries. Each time one of these federal witch-hunts would rear its ugly head SHAC would school those subpoenaed on what limited rights they have, find local activist attorneys to guide them through, and organize rallies and press visuals on the front steps of the

federal buildings. From Little Rock to New Jersey the anti-HLS campaign removed much of the power from this process. According to FBI affidavits, grand jury subpoenas were ruled out for several activists because they were such outspoken critics of the hearings and unwilling participants. {visual of grand jury protest}

### 3. NO COMPROMISE

Whether arrested or approached on a demo – do not talk to the police or FBI! No rule is more simple than this; all that is required of you is to do and say nothing. Lessons learned from the frontlines of SHAC pickets are exhibited in the current SHAC 7 case – *the government has no cooperating witnesses*. The ‘no compromise’ philosophy adopted by activists confounds the investigative process, denies leads, and limits FBI probes.

### 4. SURVEILLANCE

You can gauge your impact by the measure of the government’s surveillance. The same energy and resources they put into finding serial killers are now being poured into investigating animal rights protest activity. From the US efforts of SHAC activists we have seen high-powered listening devices, tapped phones, intercepted emails, tracking devices on cars, ‘sneak and peak’ home invasions, trash searches, mail interception, and physically following activists.

According to sworn FBI testimony anti-HLS activists became quite skilled in evading surveillance. The top tips offered included burning sensitive documents, avoiding discussing demo details on the phone, carrying on sensitive conversations in secluded locations like forests, expecting all conversations on demos are listened to, using rental cars when researching protest targets, and keeping a clean house with ‘political tools’ stored in safe non-descript locations.

### 5. THE FUN FOR ANIMALS

Likely the best contribution to a security culture this one campaign has made is that security need not be scary and it need not be boring. SHAC grabbed the attention of the grassroots with its cheeky rhetoric, flashy displays, and strict adherence to a code of silence. Its security leaflets, web banners, newsletters, and press visuals show the importance to every activist and every group that we must make protecting ourselves from a repressive state a priority.

## LESSONS LEARNED FROM THE FRONTLINES OF SHAC PICKETS IN THE CURRENT SHAC 7 CASE – THE GOVERNMENT HAS NO COOPERATING WITNESSES.





advertise with

# BITE BACK

magazine



# 10% OFF

JUST MENTION THE AD  
[WWW.DIRECTACTION.INFO/ADS.HTM](http://WWW.DIRECTACTION.INFO/ADS.HTM)  
[ADS@DIRECTACTION.INFO](mailto:ADS@DIRECTACTION.INFO)



# JUNE 10-12

## WEEKEND OF RESISTANCE FOR JEFF "FREE" LUERS

Plug in and show solidarity for this Earth liberation prisoner.

### FREEFREENOW.ORG

EAT TILL YOU PUKE.  
Vegan junk food + miscellany.  
Delivered to your door. yay.  
[FOODFIGHTGROCERY.COM](http://FOODFIGHTGROCERY.COM)



# Food Fight!

VEGAN GROCERY • PORTLAND, OR • 503-233-3910

What did you do during the eco-wars?

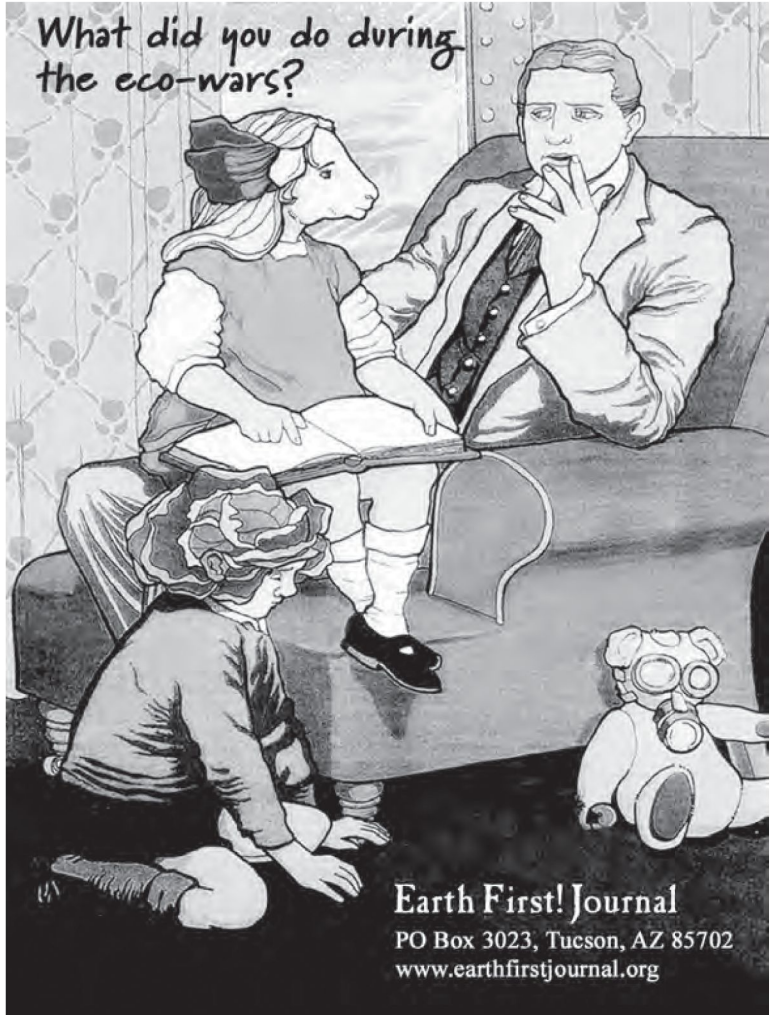

**Earth First! Journal**  
PO Box 3023, Tucson, AZ 85702  
[www.earthfirstjournal.org](http://www.earthfirstjournal.org)

## EVERYBODY'S READING IT. SUBSCRIBE TODAY!

- ★ NEWS
- ★ A.L.F. UPDATES
- ★ INTERVIEWS
- ★ SECURITY CULTURE
- ★ ACTIVIST TIPS
- ★ MERCHANDISE



### NO COMPROMISE MAGAZINE

THE MILITANT DIRECT ACTION PUBLICATION OF GRASSROOTS ANIMAL LIBERATIONISTS SINCE 1996

[WWW.NOCOMPROMISE.ORG](http://WWW.NOCOMPROMISE.ORG)  
740A 14TH ST. #125 ★ SAN FRANCISCO, CA 94114





LIBERATED AND LIVING  
THE GOOD LIFE. 

what puts a smile on Fatty's face?

when two brits gain access to 10  
labs in japan, only to return  
later to liberate him.

how it was done...

## *nice and easy* *the simplest raid in history*

In July 2001 myself and a friend went to Japan to investigate animal laboratories and take footage of the animals there. We were pretty successful in our aims; extensive footage was gained from a total of ten laboratories, hospitals and universities around the Osaka and Tokyo areas.

One of the worst places we visited was Juntendo university in Tokyo. Here we found dogs, goats, rats and mice being subjected to horrific experiments. Some of the dogs were kept in squalid, barren kennels on the roof of the building. Opposite the kennels were the laboratory buildings. Inside here it was even worse, as this was where the actual experimentation was

taking place. We filmed in two rooms which each consisted of two tiers of cages along each wall of the room, each one housing a single dog. It was like a scene from hell. Some of the dogs were purpose bred beagles, others were clearly strays which had been picked up from the street – this is common in Japan. Some had recently been subjected to brain surgery; we could see where their heads had been stitched back together leaving electrodes protruding out. One dog had a similar object hanging from his mouth. All the dogs were frantically trying to get out of their cages and many were visibly shaking with fear.

We revisited Japan in April 2002 to take part in a protest against a pharmaceutical conference in Tokyo. While we were there we decided to revisit Juntendo University, to see if conditions were still the same. Nothing had changed and the visit left us as upset as the first time we'd been there. However we were particularly astounded to find that one of the dogs we had seen the year before was still there. He was still living in the dark, wet concrete kennel block on the university roof, still shaking and cowering in the far corner, clumps of fur everywhere, scraps of food on the dirty floor along with urine and feces and he was still chained to the kennel wall. He had been living that pitiful life for at least the last year and was probably also being subjected to horrific experiments. We knew we had to try and do something. We wanted to take them all, but at the very least we had to liberate him.

Both this visit and the investigations from the previous year were only really possible because of a serious lack of security, probably comparable to the situation in the UK in the early 80s. Some places had been easy targets, some not so easy, but only a few were impenetrable. Juntendo presented few problems – we were able to walk in and out with ease and attracted little attention. It was only when I was arrested and imprisoned the following year for this “theft” and for the other investigations that I realized how lucky we had been. I now know how seriously the Japanese authorities regarded these so called crimes. They were outraged and felt genuinely threatened by the fact that we had exposed their secrets.

In order to liberate the dog we had by now nicknamed Fatty we knew we would need some help. Taking him wasn't going to be the problem - it was the getting away afterwards and the long-term care we needed help with. After much thought we decided to ask two of the Japanese people who had protested with us at the pharmaceutical conference. We didn't expect them to agree as they hardly knew us and had probably not done anything like this before. But they agreed without hesitation, saying that if we were prepared to take the dog then this was the least they could do to help. This was a brave decision to make, given what I know now about the Japanese custodial system and their culture.

Sitting on the floor of their tiny animal rights office we came up with a simple plan and put it to them. After hours of discussion in broken English they understood and agreed. We set off for the university in their car, stopping off on the way to buy a collar and lead and a rather large bag. Within an hour we were parked outside the hospital section of the university complex.

Dressed up in our smart clothes we re-traced the route we had taken so many times before; into the building via a walkway that joined the hospital and university, taking the lift to the fifth floor, through the doors on to the lower roof, up two flights of open stairs to the second roof, through a strange gate that seemed to serve no purpose and across this final roof towards the animal house.

It was around 1pm on an unbearably hot and sunny day. The place was bustling with doctors and students but it's amazing where confidence and smart clothes can get you!

Fatty lived in a row of old dirty kennels situated on the right hand side of the roof. We entered his kennel and released him from his chain. He couldn't bark because he had been devocalized, but as we put a collar and lead on him, and led him out of the kennel he immediately started to wag his tail. He was enjoying his first taste of freedom and just wanted to sniff and investigate everything, but now perhaps wasn't the best time! We were pouring with sweat, standing on a roof surrounded by skyscrapers and just waiting for someone to turn up and catch us. Eventually Fatty followed us to a slightly more secluded area where we were able to crouch down and, unfortunately for him, squeeze him into our bag.

That done we made our way back across the roofs and into the lift. He was very heavy and we were dripping with sweat. Imagine our horror when the elevator doors opened on the ground floor to reveal three men in white lab coats. We smiled and they waited while we left the lift – the politeness of the Japanese had never come at a more perfect time!

A couple of minutes later we were back in our waiting car, Fatty was out of the bag and had his head out of the open window, loving the cool breeze on his face. I swear he was smiling. We said goodbye to him at the vets that night, he stayed there over night to be checked out, and the next day he was off to a small rescue centre, which our friends had a part in running.

The next day was our final day in Japan. We were happy for Fatty but not quite content. My friend decided to go back once more and see what else he could liberate. We desperately wanted to get a very young beagle puppy we had seen in the indoor laboratory. Unfortunately the door to the laboratory was locked and he returned without the puppy but not completely empty-handed. One of the outbuildings was open and he found and rescued three beautiful brown and white mice.

It will always be difficult to think of the animals that we saw, touched, filmed and left behind. The only good thing is that we know that Fatty is still living his new life in a beautiful house in the country, at the foot of the mountains a hundred miles from Tokyo.

BB



**FATTY, A YEAR EARLIER,  
BEHIND BARS IN JAPAN**

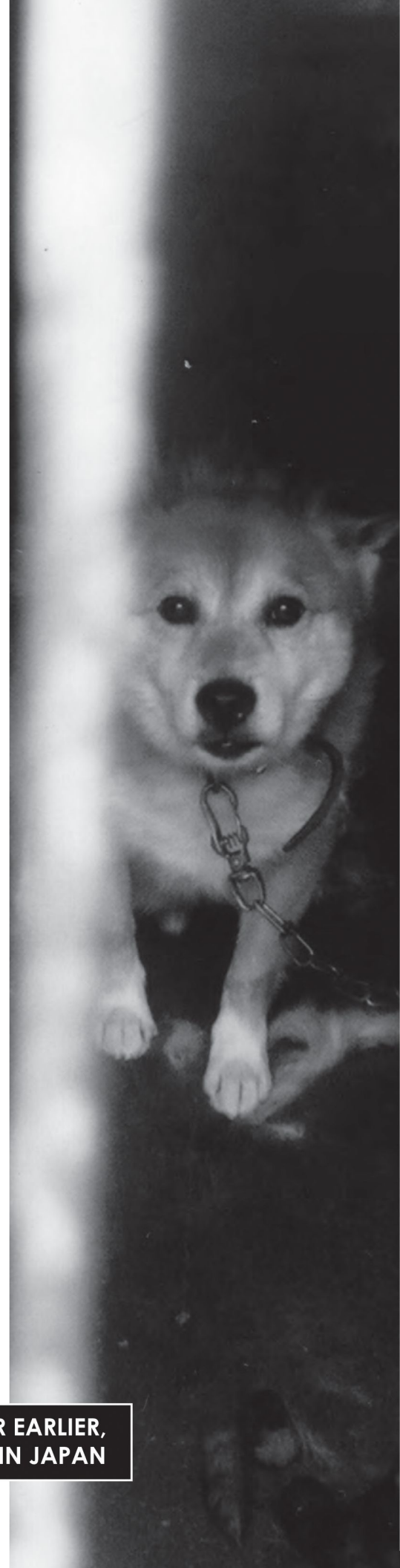



# IT ALL ADDS UP

[ it all adds up ]



# 2

The number of CEO's McDonalds saw die in less than twelve months from meat-diet related diseases (coronary artery disease and colon cancer).'

[ sound bites ]



"The world just has no idea what it's going to see if this thing comes... when really. It's when. I don't think we have the luxury of 'if' anymore."

- **Scott Dowell**, of the International Emerging Infections Program to the New Yorker Magazine, February 2005.



# 2

The extended length in years of the amnesty given to factory farm feedlots from the Clean Air Act by President Bush on the day of his second inauguration.

"How do I know you're not from an animal rights organization collecting information to storm the place?"

- A statement taken from one of several interviews **Joanne Kempner**, a researcher conducting a study on why scientists are either avoiding certain research or self-censoring.

# 180,000,000

THE NUMBER PEOPLE (AT LEAST) THAT ARE PREDICTED TO DIE FROM AN AVIAN FLU OUTBREAK, ACCORDING TO MICHAEL OSTERHOLM, THE DIRECTOR OF THE CENTER FOR INFECTIOUS DISEASE RESEARCH AND POLICY. UP TO 30% OF THE WORLD COULD BE INFECTED.

"When the Judge said 6 years, I just smiled, held my head high and thought of what is to come - ACTION."

- **Sarah Gisbourne**, a UK activist just sentenced for 'Conspiracy to cause criminal damage' in relation to the UK SHAC campaign.

## the ANIMAL RIGHTS corner

# 400,000

The number of man-hours Cambridgeshire police has spent on SHAC demonstrations since 2005, costing an estimated 5.4 million pounds, as reported by the Times, Feb 28th, 2005

# £1,000,000

The amount the UK government will contribute to the construction-stalled controversial Oxford animal research lab to deal with animal rights activists.

# £300,000

How much Cambridge University's SimuGen project, which completely eliminates the "need" for animal research in drug development, needs to produce its proto-type test kit.

"There are few informants or cooperating witnesses involved in domestic terrorism offenses. The animal rights activists adhere to a "no compromise" philosophy, thus making cooperation with law enforcement very rare."

- **FBI affidavit** submitted in the SHAC7 investigation and prosecution.

"Having largely beaten McDonalds, and won some damaging judgments against them in our trial, we have now exposed the notoriously oppressive and unfair UK laws. We hope that this will result in greater public scrutiny and criticism of powerful organizations whose practices have a detrimental effect on society and the environment."

- **Helen Steel** and **Dave Morris**, after the European Court on Human Rights declared that their 314 day McLibel trial was biased and unfair.



# HISTORY LESSONS

*weathering government repression.*

Grand juries. Federal indictments. Hefty jail sentences for minor actions. FBI visits. Interrogations. The laundry list of government repression the animal rights movement has endured over the last several years goes on. Will it end? Will we survive? Looking back over other social movements, some survived the harassment and others were squashed.

It's time to crack open the history books and learn from social movements past how to survive.

## Lesson One: *Generate Mass Community Support*

In the 1960s the birth of the Black Panther Party brought optimism and activism to African American communities nation wide. While radical and militant, the BPP also sought to bring about change on a very grassroots, local level, with free food programs, assistance for the elderly, free health clinics, and other social programs. When the authorities swooped in to stomp out this growing threat, the government harassment initially elicited broad support for this new, militant, highly visible national organization and its popular ten-point socialist program for Black self-determination. When Huey Newton, a founder of the BPP, was arrested on bogus murder charges, the community rallied by the hundreds in a campaign to free him. And the party thrived.

Unfortunately, years of sustained government harassment and psychological warfare eventually lead to the demise of the party, proving that it takes more than just community support to survive COINTELPRO type tactics.

## Lesson Two: *Go Underground*

For many anti-war and anti-imperialist activists of the 60's, too many arrests, beatings, killings, and set-ups lead to a deep-seated mistrust of the government and acceptable channels for social change. While guerilla groups were virtually non-existent in the early years of the anti-war movement, the violent assaults and covert manipulation by police and other authorities eventually helped to push some of the most committed and experienced groups to withdraw from grass-roots organizing and to substitute armed actions. Thus were born groups like the Weather Underground and the SLA, who carried out dozens of violent attacks on individuals and institutions they deemed to be associated with U.S. imperialism.

## Lesson Three: *Change Tactics*

Although sometimes strategic, most times groups change tactics (either going mainstream or underground) to avoid further harassment by authorities. Looking again at the Black Panther Party, by the 1980's, the party was all but dead. However, some original Panthers survived and from its ashes revived the party to become a player in municipal politics and community development. No longer the gun-toting, fiery group it had once been, the Party took a more acceptable role in mainstream social change.

## Lesson Four: *Not Everyone Makes It*

COINTELPRO—the now infamous FBI counter intelligence program designed to destroy the social movements of the 1960s and 70s—succeeded in many respects after years of resistance.

We now know it successfully:

- Distorted the public's view of radical groups in a way that helped to isolate them and to legitimize open political repression.
- It reinforced and exacerbated the weaknesses of these groups, making it very difficult for the inexperienced activists of the Sixties to learn from their mistakes and build solid, durable organizations.
- COINTELPRO often convinced its victims to blame themselves and each other for the problems it created, leaving a legacy of cynicism and despair that persists today.
- By operating covertly, the FBI and police were able to severely weaken domestic political opposition without shaking the conviction of most US people that they live in a democracy, with free speech and the rule of law.

We see the results of COINTELPRO today. What we can learn is:

- The repression and harassment will end.
- Strong security culture and resistance will render our movement nearly impenetrable.
- History repeats itself. We must learn from the harassment of activists past, and our movement will survive and become stronger.



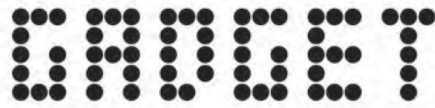
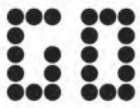

MAKING RAIDS EASIER ONE TOOL AT A TIME.

Now we can't say we're talking from experience, but rather from acute observation. We've read enough 'how it was done' and 'what went wrong' and communiques and have watched enough direct action videos to make the educated statement:

"Too bad you didn't have this."



## SLIDE SLEDGE

Now how many times have you come across a locked door in a cramped hallway or a restraining device in a small closet and thought "it's clobberin' time"? Only one thing will take care of this problem, and that's your trusty sledgehammer. Except when you go into your mighty back swing there just isn't enough room to do the job.

Enter the "SlideSledge Heavy Equipment Hammer".

This bad boy eliminates the need for a back swing. Not only does it do away with sore muscles, it delivers a "powerful pay-load of impact for extreme applications." We couldn't have said it better.

According to the manufacturer, this pup "effortlessly delivers over 15,000 PSI of impact force," is "ideal for field maintenance", and allows "two person jobs (to) now be completed by one." Not only is this hammer powerful, it's a snitch reducer.

[www.slidesledge.com](http://www.slidesledge.com)

## WHAT ELSE YOU GOT?

### FISHER FVD-C1 POCKET CAMERACORDER

We've all sat down in front of the TV, filled with excitement and anticipation, and popped that label-less video in to the VCR. Wide eyes stare at what one hopes will be a video filled with animals rushed off to safety and constant rewinding of that one part where those instruments of death are smashed apart. Instead you get: "what the hell is that?"

No more. This camera will bring your next action into crisp DVD quality film, CD quality audio, and literally fits in the palm of your hand. At 4.3" high and 2.7" wide, you can throw it in your pocket without a problem. But it doesn't stop at video. This camera will also take up to 491 3.2 megapixel pictures, without disturbing your video recording.

Perhaps best of all, everything is stored on the included 512MB memory card, which is the size of a stamp. Now we're not suggesting one destroys the evidence of a federal crime, that would be illegal, but at that size one could smash it with a hammer and melt it with a lighter in a matter of seconds.

[www.fisherav.com](http://www.fisherav.com)



# S.O.L.A.G. GLOVES

We know what you are thinking - gloves? What's the deal? These aren't just gloves. They're the S.O.L.A.G Full Finger Kevlar gloves. Yes, kevlar, the stuff they make bulletproof vests out of.

These pups are not only graded for 4 season wear with excellent dexterity easy on/off capability, but they are slash and cut proof.

We've read the warnings in the Final Nail: those mink like to bite (who can blame them?). The ALF Primer has a few suggestions for dealing with pesky barbwire. And you can't read anything on direct action without it being stated that you HAVE to wear gloves.

Well, these gloves cover all your bases. With kevlar you'll be opening cages regardless of whats nipping at your fingers, hopping the biggest and baddest wall of wire they can throw up and of course, you'll leave no trace.

Lets just hope you won't have to stop any bullets.

[www.blackhawk.com](http://www.blackhawk.com)



# JOIN TODAY!

Revolutionary Organizations for Animal Rights, or ROAR, exists for various grassroots organizations with similar approaches to animal rights to benefit from a more cohesive association.

Instead of a great number of organizations wastefully floundering around independently, ROAR allows the groups to unite, while remaining completely autonomous in leadership and function. Groups can work together on maintaining an additional regional web site and email lists that allow greater access for group-to-group activities. This increase in reconciliation creates a scenario that allows better-organized and larger actions.

ROAR also provides the additional services:

- ★ Graphic Design
- ★ Basic Web Design
- ★ Banner Loans

LEARN MORE AT OUR SITE:  
[WWW.ROAR-USA.ORG](http://WWW.ROAR-USA.ORG)

# ROAR-USA

ROAR-USA | po box 151 | cape may, new jersey 08204 | [www.roar-usa.org](http://www.roar-usa.org) | [info@roar-usa.org](mailto:info@roar-usa.org)





# diary of action november to march

## liberations.

**11/18/04 (Argentina)** One rabbit rescued from pet store in Buenos Aires.  
**11/28/04 (Germany)** 16 rabbits liberated from a farm in southern Germany.  
**December (Ireland)** ALF rescued 8 chickens and 10 turkeys from two factory farms.  
**12/04/04 (Ireland)** Wild birds freed from cages in Limerick City.  
**12/17/04 (Spain)** Two dogs liberated from University of Barcelona.  
**12/24/04 (UK)** 15 turkeys liberated from factory farm.  
**12/29/04 (Argentina)** 12 rabbits and 13 hens rescued from farm near Buenos Aires.  
**12/30/04 (Sweden)** DBF liberated 60 rabbits from meat farm in Orust.  
**01/01/05 (New Zealand)** ALF liberated 22 hens from Eggs R Us in West Auckland.  
**01/02/05 (Australia)** Two chickens rescued from a broiler shed.  
**01/18/05 (USA)** ALF cut fences and released a deer herd from a venison farm in San Miguel, California.  
**01/28/05 (New Zealand)** ALF liberated 16 hens from a farm north of Auckland.  
**February (Ireland)** Foxhound found straying after a hunt in County Kildare was rescued and rehomed.  
**02/11/05 (New Zealand)** 35 hens liberated from a farm south of Auckland.  
**02/14/05 (USA)** In an open action, activists from the Animal Protection & Rescue League rescued two hens from a California factory farm.  
**02/24/05 (New Zealand)** 40 hens rescued from egg farm south of Auckland.  
**02/27/05 (USA)** ALF liberated 12 ducklings from factory farm in California.  
**03/06/05 (UK)** 50 hens rescued from a farm in Hampshire.

## sabotage.

**11/26/04 (UK)** ALF torched vehicles and offices of International Product Supplies (HLS supplier) near Mansfield.  
**December (Finland)** Windows smashed at fur shops in Tampere.  
**December (Netherlands)** ABN AMRO cash machine sabotaged in Arnhem.  
**12/03/04 (Germany)** Fur shop windows

smashed in Darmstadt.

**12/04/04 (Italy)** "During lunch break," windows etched at fur shop, and McDonald's toilet damaged, in Parma.  
**12/04/04 (Netherlands)** Seven ABN AMRO cash machines vandalized in Nijmegen.  
**12/06/04 (Italy)** Supporter of Morini farm had her car paint-stripped.  
**12/07/04 (Sweden)** In a daylight attack, Swedish ALF etched the windows and paint-stripped a luxury car of a fur store owner in Malmo.  
**12/08/04 (Spain)** Anti-bullfighting slogans painted in Pamplona.  
**12/09/04 (USA)** Host of a party for HLS customer Forest Laboratories flooded with over 1000 large e-mails.  
**12/10/04 (Germany)** Paint bombs thrown at house of P&C (fur retailer) manager.  
**12/10/04 (Netherlands)** Locks glued at TNO Zeist, and slogans painted at TNO in Delft, in protest of its connection to HLS and the Biomedical Primate Research Center.  
**12/11/04 (Germany)** Slogans painted and four vehicles sabotaged at Fisher Scientific (HLS supplier) in Schwerte.  
**12/12/04 (Netherlands)** 40 circus signs destroyed, paintbombs thrown at Circus Carre in Amsterdam.  
**12/12/04 (Germany)** Two hunting platforms destroyed in Kamenz; nine platforms destroyed in Blankenheim.  
**12/12/04 (Spain)** Locks glued and slogans painted at three butcher shops, a fish shop and a pet store.  
**12/14/04 (Sweden)** Fire extinguisher emptied into the fur shop Palskonfektin in Malmo; the store has been hit more than 40 times!  
**12/14/04 (Sweden)** In a daylight action, two windows etched at fur shop Nordiska Pals in Malmo.  
**12/14/04 (Germany)** Circus advertisements destroyed in Münster.  
**12/14/04 (Italy)** Locks glued at butcher shops and fur stores in Arezzo.  
**12/17/04 (Turkey)** Two hunter's vehicles firebombed in Izmit.  
**12/22/04 (Sweden)** More than 20 fur trim jackets destroyed at stores in three cities.  
**12/22/04 (USA)** Horse carriages sabotaged in Santa Cruz.  
**12/23/04 (Austria)** In a night of action against fur in Vienna, 10 windows etched at a P&C store, windows smashed and locks glued at two fur shops, and slogans

painted on the home of a P&C director.  
**12/24/04 (Netherlands)** Two ABN AMRO cash machines destroyed and one branch painted with slogans protesting the banks connection with BPRC primate center.  
**12/24/04 (Germany)** ALF destroyed hunting platform in Hagen.  
**12/25/04 (USA)** Two cars paint-stripped and slogans painted at home of Los Angeles Animal Services employee.  
**12/27/04 (Austria)** Windows smashed at fur shop in Vienna.  
**12/28/04 (Germany)** Car covered in paint stripper at offices of P&C in Düsseldorf.  
**12/29/04 (Israel)** Slogans painted and five windows broken at Bar-Ilan University's brain research center.  
**12/30/04 (USA)** Files stolen, computers and a TV smashed at Seaboard Securities (HLS market maker) in Florida.  
**12/30/04 (Finland)** Windows smashed at fur shop in Jyväskylä, and windows etched at six fur shops in Turku.  
**12/31/04 (Austria)** Hunting platform cut down in Lower Austria.  
**12/31/04 (Italy)** Fireworks exploded 8 windows at a UPIM department store in Milan.  
**12/31/04 (Netherlands)** Two hunting platform burnt down in Heerde.  
**12/31/04 (Germany)** Home of P&C manager hit with paint bombs in Meerbusch.  
**12/31/04 (Spain)** Two fur stores in Barcelona spray-painted and locks glued.  
**January 2005 (UK)** In Nottinghamshire, windows smashed at leather store, butcher shop and betting shop; three trucks at dairy company had tires slashed.  
**January (USA)** Window smashed and smoke flare tossed inside offices of HLS market maker Legacy Trading in Oklahoma.  
**01/01/05 (Netherlands)** Two hunting platforms destroyed in Millingen.  
**01/04/05 (Spain)** Locks glued and red paint poured at fur shop in Seville.  
**01/05/05 (UK)** Tires slashed and "Monkey Killer" painted on car of Oxford Univ. director.  
**01/05/05 (UK)** Gates glued and slogans painted at home of UTI (HLS supplier) director.  
**01/06/05 (Netherlands)** Four ABN AMRO cash machines sabotaged in Arnhem.  
**01/06/05 (UK)** Slogans painted and three

cars vandalized at home of Heathrow Airport director in protest of airport's role in vivisection industry.  
**01/07/05 (UK)** Two cars sabotaged at home of Benair (HLS supplier) director.  
**01/08/05 (France)** 150 fur store windows in Paris covered in slogans.  
**01/08/05 (Spain)** In one week, locks glued and slogans painted at eight fur stores in Barcelona.  
**01/08/05 (Ireland)** ALF placed incendiary devices at hare-coursing venue Powerston Park Racecourse, and spread nails and tacks on the field.  
**01/08/05 (Sweden)** Windows etched at fur store in Helsingborg.  
**01/09/05 (Spain)** Slogans painted at hunting store in Barcelona.  
**01/09/05 (Switzerland)** UPS building and van near Lugano paintbombed.  
**01/09/05 (UK)** Six trucks paint-stripped and had tires slashed at Bardills Aquatic Centre/Japanese Water Gardens because they hosted traveling circus.  
**01/10/05 (Germany)** Front gate glued at vivisection supplier Harlan-Winkelmann in Borcheln.  
**01/11/05 (Sweden)** Slogans painted, locks glued at five fur shops in Ostermalm.  
**01/11/05 (Sweden)** Locks glued at Nordea office in Stockholm in protest of bank's sponsorship of pro-fur website.  
**01/11/05 (Sweden)** Fur shop in Gothenburg covered in paint.  
**01/12/05 (Sweden)** Locks glued, slogans painted at two fur stores in Malmo.  
**01/12/05 (Austria)** Windows etched at two fur stores in Vienna.  
**01/13/05 (Sweden)** Fur store in Malmo hit with paint bombs; locks glued at another store, and anti-fur slogans painted in town.  
**01/13/05 (Netherlands)** Hunting platform sabotaged in Veluwezoom national park.  
**01/14/05 (USA)** Five windows etched at fur store in Pensacola; window of store owner's sports car also etched.  
**01/14/05 (Netherlands)** DBF redecorated cars and homes of three ABN AMRO employees in Enschede.  
**01/15/05 (Spain)** Tires punctured on van of HLS-supplier UPS.  
**01/16/05 (Norway)** Three windows smashed and slogans painted at fur shop in Drammen.  
**01/17/05 (UK)** ALF visit homes of Novartis employee in Hampshire,

Phenomex employee in Macclesfield, and Euro DPC employee in Chester (HLS clients/suppliers).

**01/18/05 (USA)** Four cars at home of Teva Pharmaceuticals (HLS-client) CEO covered in paint stripper.

**01/18/05 (UK)** ALF vandalize home of Danzas (HLS supplier) director.

**01/21/05 (UK)** In memory of Jill Phipps, cars sabotaged at homes of three directors of HLS-supplier FedEx.

**01/21/05 (UK)** Activists visit home of DHL Air (HLS collaborator) employee and vandalize her car.

**01/23/05 (Sweden)** Fur store in Malmo hit with paint bombs.

**01/25/05 (Germany)** Hunting platform sabotaged in Humwald.

**01/25/05 (Sweden)** Windows smashed and paint bombs thrown at fur store in Helsingborg.

**01/25/05 (Sweden)** DBF burnt down building at fur farm outside Svenljunga.

**01/28/05 (Netherlands)** Hunting platform sabotaged in Groenlanden.

**01/28/05 (Sweden)** Arson attack at dog food company outside Varberg owned by relative of fur feed producer.

**01/29/05 (USA)** Two employees of HLS customer Teva Pharmaceuticals visited at home; locks glued, garbage strewn across lawn.

**01/29/05 (Sweden)** Windows smashed, paint and stinky liquid thrown into fur shop in Helsingborg.

**01/31/05 (Netherlands)** Hunting platform burnt down in Epe/Heerde, the fifth to burn in the area in recent months.

**01/31/05 (UK)** Tires slashed on nine vans belonging to HLS-supplier DHL in Poole.

**01/31/05 (Netherlands)** Arson attack at Covance offices in Zeist.

**02/01/05 (USA)** Slogans painted at taxidermy shop in Arkansas.

**02/02/05 (Spain)** Windows broken and locks glued at offices of HLS-supplier UPS near Barcelona.

**02/03/05 (Netherlands)** Slogans painted against BPRC primate lab in Arnhem and Nijmegen.

**02/03/05 (Italy)** Two rocks thrown through windows at CRM, vivisection lab in Cesenatico.

**02/05/05 (UK)** Home of president of HLS customer Bachem painted.

**02/05/05 (France)** Three fur shops in Paris had windows graffitied and locks glued.

**02/05/05 (Sweden)** Locks glued at two fur shops in Stockholm.

**02/06/05 (UK)** In memory of Jill Phipps, employees of HLS collaborators UPS and Biocare visited at home; slogans painted, vehicles covered in paint-stripper.

**02/06/05 (Sweden)** Locks glued at fur shop and a McDonalds, in memory of Jill Phipps.

**02/06/05 (USA)** Windows smashed and slogans painted at a McDonalds in California.

**02/07/05 (Sweden)** Two fur stores in Malmo hit with paintbombs, and screens cut.

**02/07/05 (USA)** Activists went on spending spree with credit card of Plantex (Teva Pharmaceuticals subsidiary) executive.

**02/09/05 (New Zealand)** Holes dug in three greens, gasoline spilled and "murderers" painted at a golf course that had killed 18 ducks.

**02/09/05 (UK)** Homes of three Yamanouchi (HLS client) employees vandalized.

**02/09/05 (Germany)** Locks glued and slogans painted at fur store in Stuttgart.

**02/10/05 (Germany)** ALF paint slogans on trucks and buildings at a meat company in Stuttgart.

**02/10/05 (Netherlands)** Windows and cash machines smashed at ABN AMRO branches in Nijmegen.

**02/12/05 (Italy)** Slogans painted on UPS trucks and offices.

**02/12/05 (Sweden)** Over 40 jackets and boots made with fur trim and sheepskin cut at IKEA in Jonkoping.

**02/12/05 (Spain)** Slogans painted and building vandalized at dog breeder in Huesca.

**02/13/05 (USA)** 19 windows broken and slogans painted at KFC and McDonalds in California.

**02/14/05 (Italy)** Locks glued at two fishing stores in Milan.

**02/16/05 (Netherlands)** Locks glued and cash machines sabotaged at ABNAMRO banks in Arnhem.

**02/17/05 (Switzerland)** Locks glued and red paint splashed at Sankyo Pharma in Thalwil; locks glued at fur store and butcher shop in Zurich.

**02/17/05 (Netherlands)** Almost all ABN AMRO branches in Arnhem sabotaged with glue and paint; also, locks glued and slogans painted at bank branches in Sonsbeek, Elst, Lent and Harderwijk.

**02/18/05 (Spain)** Incendiary device placed outside fur shop in Barcelona.

**02/19/05 (Sweden)** DBF cut 12 fur trim jackets in Gothenburg.

**02/20/05 (Ireland)** Two signs advertising hunting event destroyed.

**02/20/05 (UK)** Attempted arson attack at Oxford University business.

**02/23/05 (Italy)** Paint bomb attacks at offices and homes of lawyer and architect connected to vivisector supplier Morini.

**02/23/05 (Germany)** P&C (fur retailer) manager had his car covered in mink shit.

**02/23/05 (UK)** Activists swam across a canal in the middle of a snow storm and sabotaged four cars at UPS building in Nottingham.

**02/24/05 (Italy)** Locks glued at fur stores and butcher shop in Milan.

**02/26/05 (Sweden)** Two shops selling fur trim items hit with paint bombs, McDonalds sign smashed, in Linkoping.

**02/26/05 (USA)** Windows and lights smashed, wine bottles broken, snowblower sabotaged at home of family that hired hunters to kill three bears in Tahoe City, California.

**02/26/05 (Spain)** Slogans painted at Circo Mundial circus in Zaragoza.

**02/28/05 (Sweden)** "Fur is Murder" painted on fur store in Goteborg.

**02/28/05 (Sweden)** DBF smashed three windows at fur store in Malmo.

**03/03/05 (UK)** Tires slashed and paint spilled on three vehicles at home of Fisher Scientific employee.

**03/04/05 (Italy)** Two cars belonging to government inspectors torched after they renewed license of lab animal breeder Morini.

**03/05/05 (USA)** Slogans painted at home of man arrested for dogfighting in New Orleans.

**03/05/05 (Spain)** Anti-circus slogans painted near circus, locks glued and slogans painted at several fur stores and butcher shops, in Barcelona.

**03/05/05 (Italy)** Locks glued at two butcher shops and a fur store in Milan.

**03/05/05 (Canada)** Sumitomo (HLS customer) executive had two cars covered in etching fluid.

**03/05/05 (USA)** Slogans painted in Manhattan neighborhood of HLS CEO Andrew Baker.

**03/06/05 (UK)** Tires slashed and paint sprayed on two cars of Fisher Scientific director in Leicestershire.

**03/08/05 (USA)** Activists visited homes of relatives of Skip Boruchin of Legacy trading (HLS market maker) in three cities in Nebraska; vehicles, boats and homes covered in spray paint.

**03/10/05 (UK)** Gas bomb left outside home of the daughter of the owner of infamous Newchurch guinea pig farm.

**03/13/05 (USA)** Home of General Counsel for HLS-customer Teva Pharmaceuticals visited; SUV covered in paint stripper and garage spray painted.

**03/13/05 (USA)** "Puppy Killer" painted on home of GlaxoSmithKline executive.

**03/13/05 (UK)** "Free the Lobsters" and other slogans painted on pub which was to hold a lobster eating festival.

**03/15/05 (UK)** Employees car covered with paint stripper and tires slashed at UPS depot in Nottinghamshire.

**03/15/05 (Spain)** Messages painted and mirrors broken on truck transporting pigs.

**03/19/05 (USA)** Dozens of magazine subscriptions sent to stepson of HLS CEO Andrew Baker.

In the early morning hours of **February 27, 2005**, we liberated **12 ducklings** from 29755 W. Jefferson Avenue, Tranquillity, CA 93668, a farm owned by Woodland Farms, a subsidiary of Maple Leaf Farms. Maple Leaf Farms, the largest producer of duck meat in North America, murders over 14 million ducks each year.

Until all animals are free, a.l.f."

LIBERATED 2.27.05



the NUMBERS NOVEMBER TO MARCH

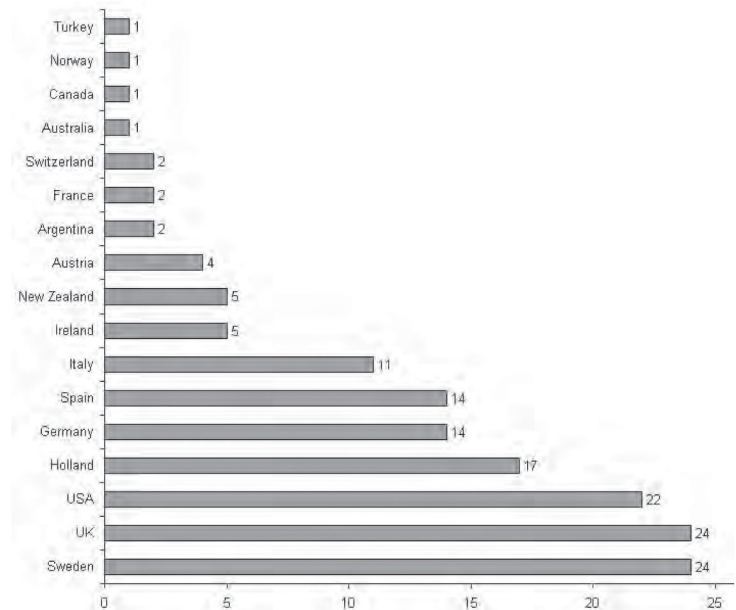

NUMBERS OF ACTIONS





## The view from the land of pubs and black taxis

The United States is different from England in many ways (remember, "chips" are fries and "crisps" are chips), but a look at the always inspiring animal rights movement in the UK can tell us a lot about what lengths a government will go to repress effective activism.

Politicians in a frenzy over animal rights is not exactly news, but in the last few years law enforcement and politicians in England have worked themselves into a state near delirium with their attempts to stifle activism.

With pharmaceutical companies threatening to abandon the UK entirely, animal rights activists have been declared "one of the most serious threats to Britain's economy." Economic disruption has become a serious concern to corporations and the government (if you can tell them apart).

Their panic is understandable. In 2004, more than 100 suppliers canceled contracts, or otherwise cut ties with Huntingdon Life Sciences (HLS). Save The Newchurch Guinea Pigs has had similar success against a company that breeds animals for laboratories. The vivisection industry is also desperate to resume construction of a half-built research center at Oxford University that has been gathering dust for months after activists forced a construction company to stop work. And a new campaign is just getting started, targeting UK airports. Their goal: a ban on the transportation (import/export) of all animals destined for labs.

The British government has tried policing, spending millions of pounds, and hundreds of thousands of police man-hours, in futile attempts to keep activists in check.

So, last November, they brought out Queen Elizabeth II (yes, the Queen!) who promised changes in the law to defend the hallowed ground of "legal economic activity." Prime Minister Tony Blair followed up with more promises, and MPs introducing a crime bill that proposed 5-year jail terms for libel (currently a civil offense), graffiti, home demos or trespassing, but only if the actions were related to animal rights. Trespass at a school or hospital, and you get sent home with a warning; trespass at an egg farm, 'that's five years in jail for you, terrorist!'

You can almost pity the politicians. They know their efforts won't make a difference, although we have to admit that the British government can be awfully bothersome for activists. Activist Heather James has been banned from going within 500 meters of HLS, for the next five years! In January, the bank accounts of London Animal Action, a grassroots group that protests circuses and fox hunts, and distributes free vegan food on the streets of London, were frozen by court order.

Of course, harassment of animal activists is not exclusive to England. In recent months, police have raided activist's homes here in America, as well as in Germany, Italy and in other countries around the world. Activists in Philadelphia are facing 18 months in jail for distributing fliers. In June, in a U.S. federal courthouse, prosecutors will attempt to make a case that SHAC-USA's website is a tool of "terrorism." Under a bill introduced in the Washington state legislature, activists who enter an animal or horticultural facility and take pictures would be guilty of "animal or ecological terrorism." People convicted under the bill would have their name, current address, and photograph entered into a registry of "animal and ecological terrorists" and posted on a public website! Fortunately, the bill does not have a chance of passing, at least this year.

Obviously, the injunctions, threats from royalty, and vague, catch-all "harassment" and conspiracy laws have not stopped protests. As a SHAC spokesperson explained, "People who break the law know the risks they are taking. Changing the law is not going to make any difference."

We are right to view government harassment as an indication of the success of our campaigning. When corporations pressure governments to act, it is because they feel vulnerable.

*"It is especially important that we stand tall at a time when the vivisection institutions, their lawyers and the State are desperately trying to reinforce and normalize ideologies of violence toward animals; we must not let them rein in our will or silence our freedoms to object to their vile catalogue of animal exploitation. These protests must and will always continue!"*

-Save the Newchurch Guinea Pigs

in CONCLUSION



**BITE BACK**  
magazine

222 Lakeview Ave.  
Ste. 160-231  
West Palm Beach, FL 33401  
BiteBack@DirectAction.info  
www.DirectAction.info

ALL PRICES INCLUDE SHIPPING & HANDLING IN THE US.  
FOR INTERNATIONAL ORDERS, CONTACT BITE BACK FOR RATES

# MERCHANDISE



'ANIMAL LIBERATION' SHIRT  
\$10 (XL only)

These old school classics are back! But in limited numbers. In fact, most are size XL only, but request another size and we might be able to help you out. An artist's rendition of the ALF rescuing animals on front on gray.

Show your pride!



'ON THE RUN'  
\$10 (6 hours, 5 cds)

Ingrid Newkirk's 'Free the Animals' comes alive on 'audio book' as she reads her favorite ALF raids. Great for commutes and road trips!



'FREE THE ANIMALS'  
\$12 (400 pages)

The true story of the ALF's beginnings in the USA, as told by Ingrid Newkirk. A powerful and inspirational read you won't be able to put down.



'MEMORIES OF FREEDOM'  
\$6 (75 pages)

The inspiring story of Rod Coronado and the Western Wildlife Unit of the ALF as they burned and liberated their way across America's labs and fur farms.

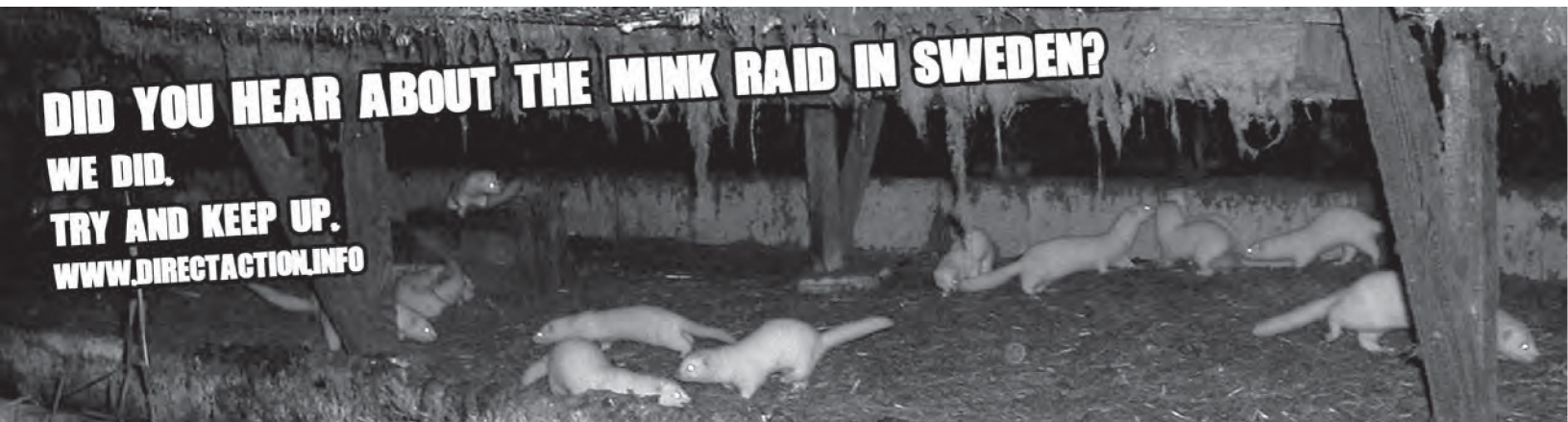

**BITE BACK**  
magazine

222 Lakeview Ave.  
Ste. 160-231  
West Palm Beach, FL 33401  
BiteBack@DirectAction.info

# SUBSCRIBE



**YES!**

Subscribe me to Bite Back Magazine for one year!

\$15 YEAR SUBSCRIPTION  \$10 STUDENT/LOW INCOME  \$20 INTERNATIONAL  
BITE BACK MAGAZINE IS FREE TO PRISONERS.



**YES!**

I want to see Bite Back continue with my support!

\$25  \$50  \$100  
 \$ \_\_\_\_\_ other

YOUR DONATION OF \$15 OR MORE WILL SECURE YOUR SUBSCRIPTION AS WELL.

name		
address		
city	state	zip/postal code

SEND ME MY ORDER

item	quantity	price





# LIBERATED

30 BEAGLES, 10 FERRETS  
12.5.2001  
NEW ROSE, NY

**BITE BACK**  
magazine

222 Lakeview Ave.  
Ste. 160-231  
West Palm Beach, Florida 3340





# Conflict GYPSY

read is the new green

this publication and many more can be  
found on [conflictgypsy.com](http://conflictgypsy.com), the free  
archive of old & rare direct action news